

smartzone[™] UPS

User Manual

Uninterruptible Power Supply

5-10kVA (SINGLE PHASE)

10-20kVA (3-PHASE)

Table of Contents

Section 1 – System Overview	3
Key Features	4
Basic Operations	5
UPS Overview	5
UPS Working Modes	5
UPS Physical Features and Options	12
Physical Features	12
UPS Options	19
Section 2 – Front Panel Display (FPD).....	25
Status LED Indicators	25
Power Button Operation	26
Turn On/Off UPS	26
Display Operations.....	28
Menu Structure	29
Display Icons	31
Initialization Page	34
Home Pages	34
Status Pages	37
Alarm Pages	44
Setting Pages	47
Maintenance Pages	66
Common Pages.....	71
About Pages	75
Appendix A1: 5 to 10kVA Fault/Alarm Codes	78
Appendix A2: 10 to 20kVA Fault/Alarm Codes	81
Appendix B: Troubleshooting	84
Appendix C: Configuration Options	86

Appendix D: 10 to 20kVA Dry contact port definition.....	89
Appendix E: 10 to 20kVA Backfeed protection port definition.....	90
Appendix F: 10 to 20kVA REPO port definition	91

Section 1 – System Overview

The Panduit SmartZone™ UPS units are true on-line double conversion systems that deliver highly efficient and reliable power protection for your computer, IT, communications, and automatic equipment. These units have high electrical performance, intelligent monitoring, and network functions to properly monitor and condition the world's power problems (power failures, power sags, power surges, under-voltages, over-voltages, electrical line noises, frequency variations, switching transients, and harmonic distortion).

Each UPS has multiple options for interfacing with the unit. The UPS can be ordered with a network card for remote network monitoring, control, and configuration, or can be ordered without a network card. Additionally, a Network Card or a Dry Contact Relay Card can be ordered as accessories.

Each UPS unit is also equipped with a serial port for limited local monitoring, control, and configuration through a PC. This manual provides the information on how to operate the system with all interfacing options.

The UPS units support VRLA (Value Regulated Lead-acid) batteries as the backup power storage system. The topology of these units is on-line double conversion with a built-in economy (ECO) mode. The on-line double conversion architecture provides the best power conditioning by recreating a true sinewave on the UPS outputs. The on-line double conversion topology converts the input AC power to a DC power and then regenerates the AC power on the UPS outputs. This double conversion allows the UPS to eliminate the inconsistencies in the input power, provided by the utility company. The UPS may be optionally switched to ECO mode to increase the unit's efficiency when the input power is known to be reliable (requires minimal conditioning).

All UPS units described in this User Manual have a 3.5-inch touch screen color display. The screen auto detects the UPS mounting orientation and auto rotates to support horizontal in-rack installation or vertical tower installation.

Key Features

- Integrated data center solution - UPS integrates with multiple External Battery Packs (EBP) and an external Maintenance Bypass Switch (MBS), offering an excellent choice for data center deployment.
- 3-Phase In/3-Phase Out UPS - The 3-Phase UPS may be configured as a 3-Phase In/3-Phase Out high-density UPS system or as a 3-Phase In/Single-Phase Out high-density UPS system.
- Digital Control - These UPS units controlled by Digital Signal Processor (DSP) which increases reliability, performance, self-protection, and self-diagnostics.
- Configurable Battery Charging Current - the user may set the battery's charging parameters to optimize battery utilization and battery life.
- Intelligent Charging Method - The UPS units have an advanced three-stage charging method to extend the battery life and guarantee fast charging.
 - 1st stage: constant current charging to guarantee to charge back to 90%.
 - 2nd-stage: constant voltage charging to make sure batteries are fully charged.
 - 3rd stage: float voltage charging to ensure the battery stays charged to the optimal level.
- User Friendly Front Panel Display – Touch Screen Color Display with Color Status LEDs allow the user to easily get UPS status and set operational parameters.
- Intelligent Monitoring Function – Standardly equipped with a Network card for remotely controlling and monitoring the UPS via a user-friendly Web Interface.
- EPO Function - These UPS units are all equipped with an Emergency Power Off (EPO) interface to shut OFF the UPS via a remote switch.

Basic Operations

The basic operations of a double conversion UPS are explained through the high-level block diagram in Figure 1.

UPS Overview

The input of the UPS is connected to an AC power source via an input plug or a hardwire connection (depending on the UPS unit purchased). The output is connected to loads via outlets or a hardwire connection on the UPS (depending on the UPS unit purchased). The AC power source for the loads is provided by the output(s) on the UPS.

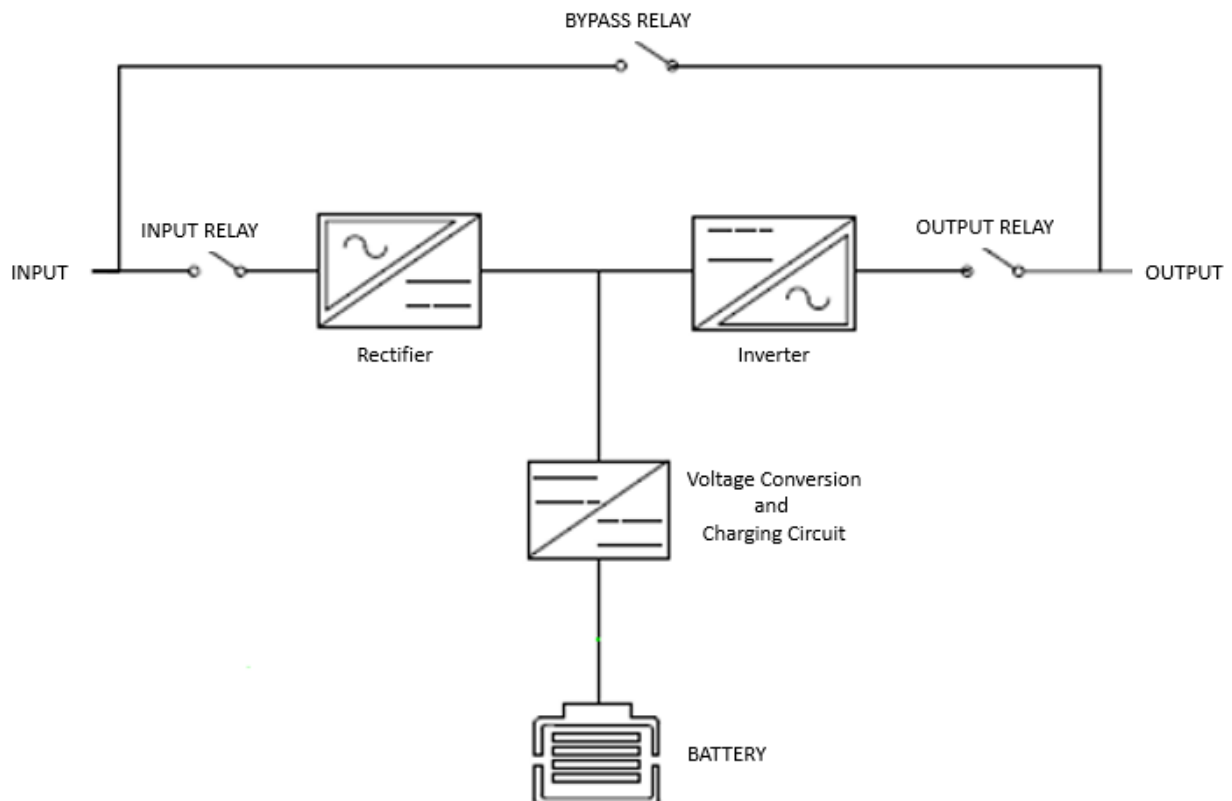

Figure 1: High-level Double Conversion UPS Block Diagram

UPS Working Modes

This section provides an explanation of the working modes that the UPS may be in at any given time. The UPS may be manually configured to operate in certain modes. The UPS may automatically transition to some of these working modes because of an internal or external event.

Normal Mode

Normal mode (on-line double conversion) is the default working mode of the UPS unit. When the UPS is operating in normal mode it provides a stable pure sinusoidal AC power output and charges the battery. In normal mode the input and output relays are closed, and the bypass (ECO) relay is open. The rectifier/charger derives power from the AC Input and supplies DC power to the inverter while simultaneously boost/float charging the battery. The inverter converts the DC power to AC and supplies to the load with a stable pure sinusoidal AC power.

If input power is lost while the UPS is operating in normal mode, the UPS automatically transition to battery mode. In battery mode the battery will stop charging and start providing the DC power to the DC to AC inverter, continuing to provide AC power to the load.

If an internal fault or an overload occurs while operating in normal mode, the UPS automatically transitions to bypass mode. In bypass mode the input and output relays open and the bypass relay closes, continuing to provide unconditioned AC power to the load.

ECO Mode

When the UPS is in Normal Mode and the requirement to the load is not critical, the UPS can be set at ECO mode to increase the efficiency of the power supplied. When the UPS is manually be configured for Energy Savings (ECO) mode, the output replay opens, and the bypass relay closes. The input relay remains closed, continuing to keep the VLRA backup batteries charged. In ECO mode, the UPS works at Line-interactive UPS. In ECO mode the source power is not fully conditioned as in normal mode.

If the input power is lost while the UPS is operating in ECO mode, the batteries will stop charging, the bypass relay will open, the output relay will close and the battery will start providing the DC power to the DC to AC inverter, continuing to provide AC power to the load.

If an internal fault or overload occurs while operating in ECO mode, the bypass relays will open and the output will shut down, AC power to the load will be lost.

Convert Frequency (CF) Mode

By default, CF mode is not enabled. This mode may be manually enabled. When this mode is enabled, the UPS may be used in a condition where the output frequency needed does not match the input frequency. When 50Hz input frequency is converted to 60Hz on the output, the UPS output must be derated to 75%. When 60Hz input

frequency is converted to 50Hz on the output, no UPS derating is required. When this mode is enabled, the bypass mode is automatically disabled (the unit cannot switch to bypass mode under any conditions). CF mode works in conjunction with normal mode only.

If input power is lost while the UPS is operating in CF mode, the UPS automatically transitions to battery mode. In battery mode the battery will stop charging and start providing the DC power to the DC to AC inverter, continuing to provide AC power to the load.

If an internal fault or overload occurs while operating in CF mode, the output relays will open and the output will shut down, AC power to the load will be lost.

Generator Mode

By default, generator mode is not enabled. This mode may be manually enabled. This mode enables the UPS to have a wider input frequency range (40Hz to 70Hz). When this mode is enabled the UPS output must be derated to 70% of the maximum output. Note: Generator mode is not a settable option on the 3-Phase UPS units because these units always operate with a wider frequency range; 3-phase UPS units always operate in generator mode with no derating. Generator mode works in conjunction with normal or ECO mode. NOTE: If operating in ECO mode and generator mode is enabled, ensure that the loads can support the 40 to 70Hz frequency variations.

The generator mode will not be saved. When the UPS is powered off and restarted, it will automatically return to Normal mode.

If input power is lost while the UPS is operating in generator mode, the UPS automatically transition to battery mode. In battery mode the battery will stop charging and start providing the DC power to the DC to AC inverter, continuing to provide AC power to the load. After the generator starts providing stable power, the UPS will automatically transition back to normal or ECO mode, whichever mode was configured on the UPS.

If an internal fault or overload occurs while operating in generator mode, the UPS will follow the conditions stated above for either normal mode or ECO mode depending on the working mode configured in the UPS.

NOTE: Generator Mode will not be saved when the UPS is powered OFF and restarted. Generator mode will need to be enabled again on the 5-10kVA single phase UPS units.

Battery Mode

The UPS automatically transitions into battery mode with no power interruption when input voltage is abnormal or is lost. The UPS may manually be put into battery mode, indirectly, by manually running the battery test. The UPS will automatically return to Normal Mode when the input sources recover.

If an internal fault or overload occurs while operating in battery mode, the output relays will open and the output will shut down, AC power to the load will be lost.

Bypass Mode

The UPS automatically transitions into bypass mode with no power interruption when an internal fault or output overload occurs. The UPS can also be set to bypass mode by turning OFF the inverter (press the ON/OFF button on the Front Panel Display), but the input voltage and frequency must be within the specified ranges as specified in settings. In bypass mode the source power is not fully conditioned as in normal mode.

If an internal fault or overload occurs while operating in bypass mode, the output relays will open and the output will shut down, AC power to the load will be lost.

If input power is lost while operating in bypass mode, the output relays will open and the output will shut down, AC power to the load will be lost.

Maintenance Bypass Mode

The UPS may be switched into maintenance bypass mode to perform periodic maintenance on the UPS. The maintenance bypass switch will electrically disconnect the UPS from the system. When the UPS is switched to maintenance bypass mode the CB1, CB2 and CB4 are opened, and CB3 is closed. In maintenance bypass mode the source power is not conditioned as in normal mode. NOTE: Maintenance bypass mode is supported on the 3-Phase UPS units only.

If input power is lost while operating in maintenance bypass mode, AC power to the load will be lost.

Fault Mode

The UPS automatically transitions into fault mode when the UPS is unable to provide power to the load. The input, output and bypass relays are all open.

Battery Test Mode

The UPS may be manually or automatically put into the battery test mode, but the UPS will automatically transition back to the previous mode when the test is complete. The battery test may be manually executed at any time. The battery test may also be

scheduled to automatically run at a predetermined interval. As part of executing the battery test, a test duration must be specified.

The frequency and duration of the battery test have an impact on the battery life. A longer test duration will provide more accurate results but will cause the UPS to have a longer recovery time (battery charge will be farther depleted and it will take longer to charge the battery to allow the UPS to provide the specified run time when needed).

System Configuration Modes

Single Mode

All UPS units by default are configured as a single mode system. A single mode system is a single UPS connected to an AC power source and that UPS provide the AC power to the load.

Parallel Mode

All 3-phase UPS units may optionally be configured into a parallel mode system. A parallel mode system allows two to four UPS unit of the same SKU to be connected in parallel. NOTE: Initial release of the product only allows two UPS units to be connected in parallel. The parallel mode allows the group of UPS units to behave as one large UPS system. NOTE: There are critical restrictions for connecting these units in parallel.

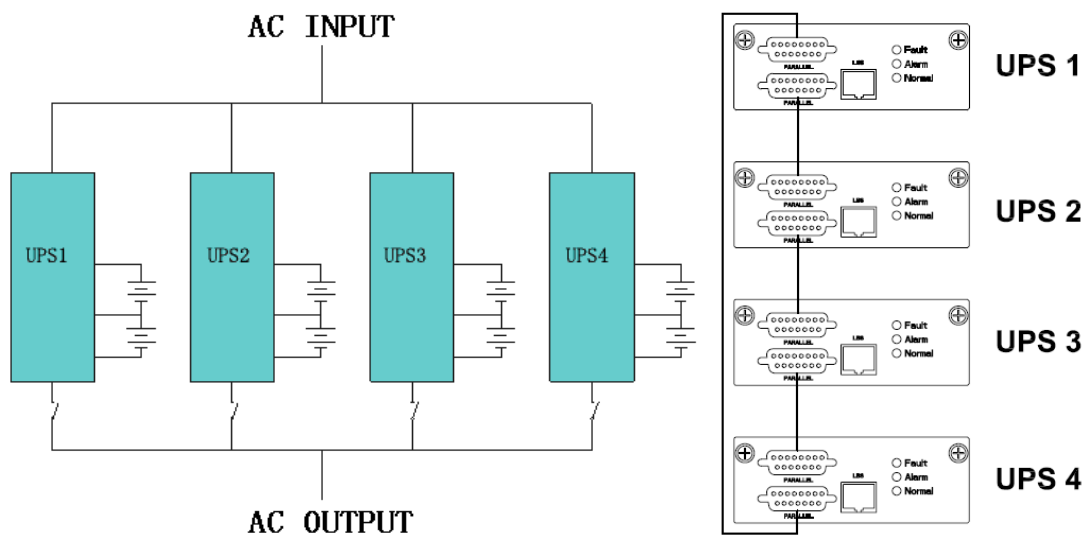

Figure 2: Parallel System Power/Control Connections

Parallel Mode Restrictions

To ensure that all UPS units in the Parallel mode configuration are equally utilized and comply with relevant wiring rules, the following restrictions must be met:

- All UPS units must be of the same rating.
- The input of all the UPS units must be connected to a common input bus.
- The output of all the UPS units must be connected to a common output bus.
- The length and specification of all UPS power cables (main input, bypass input and the output cables) should be the same type and same length. This helps to facilitate load sharing between the UPS units when operating in ECO/bypass mode.

Parallel Mode Setup and Startup

Each UPS unit in the Parallel mode system must be properly configured before the Parallel mode system is powered up.

- Confirm that all breakers in the Parallel Mode system are open.
- Confirm that the Input/Output power connections and the input phase sequence is correctly connected.
- Confirm that the +/- battery voltage of all EBP groups are correct.
- Confirm that the parallel control cables are connected in a ring configuration between all UPS units in the Parallel mode system (control connection in Figure 2).
- Power ON the first UPS unit and set the working mode to Parallel, set the Parallel ID to 1, set the number of parallel UPS units to the number that will be in the system (2-4), set the ID of the redundant UPS unit, if redundancy is desired in the system (0-3, no redundancy = 0). Require setting the in series number, capacity of battery. The output voltage level and Bypass protection range are default setting.
- Power OFF the first UPS unit, make sure the UPS is OFF. Power on the second UPS unit and follow the configurations steps above for the second UPS unit. This unit should have all the same settings except the Parallel ID on this UPS unit should be 2.
- Make these configuration settings for the rest of the UPS units in the Parallel mode system; making sure the Parallel ID is unique for each UPS unit.
- After all UPS units in the Parallel mode system are configured, power ON the

UPS units in ECO mode and confirm that all settings are correct. Each UPS unit should have a unique Parallel ID.

- Then turn ON all battery breakers and confirm the parameter (V/I) are normal.
- Set all units in the Parallel mode system to normal mode.
- Then connect the load(s) and confirm the output current from the system is balanced.
- Toggle the utility breaker ON and OFF to test all the UPS converter systems from the utility to battery and restore function are properly working.

UPS Physical Features and Options

The following sections provide an overview of the human and electrical interfaces on the UPS unit. All UPS units are rack mountable with a display on the front side of the unit.

Physical Features

UPS Front Panel

The UPS Front Panel for all 5to10kVA 1-Phase and 10-20kVA 3-Phase Models are the same. The front panel contains four Status LEDs, a 3.5-inch color touch screen display and a power ON/OFF button.

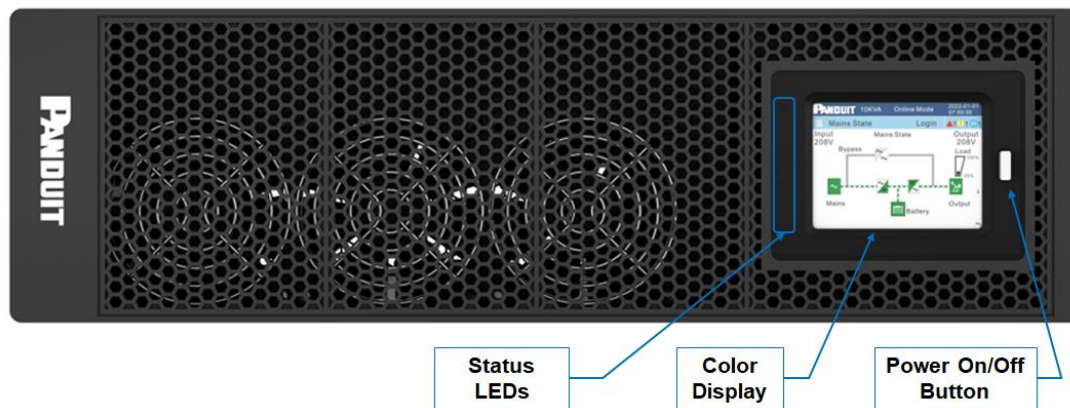

Figure 3: 5to20kVA Front Panel

Status LEDs

Each unit has four Status LEDs that provide a quick high-level view of the units operating conditions.

- Normal LED (Green sinewave) – indicates the unit is operating in normal mode.
- Battery LED (Yellow battery) – indicates the unit is operating in battery mode.
- Bypass LED (Yellow bypass)– indicates the unit is operating in bypass mode.
- Alert LED (Red or Yellow)– Red indicates that the unit has an active Fault, yellow indicated the unit has an active Alarm.

Color Display

The unit has a 3.5-inch touch screen color display. This display is used for monitoring, control, and configuration. The display will automatically adjust to the orientation of the unit.

Power ON/OFF Button

The UPS has a single push button switch to the right of the display. This push button switch is to power ON or OFF the UPS.

UPS Rear Panel

The rear side of the unit varies based on the part number of the unit (refer to Figures in this section).

Intelligent Slot (5)

The UPS can be ordered equipped with a Network management Card. Alternatively, the UPS may be ordered with an empty Intelligent Slot, and latter updated with a UPS Network Management Card or a UPS Relay Card

Maintenance Bypass Signal Port (MAINT.)(6)

All units have Maintenance Bypass Signal port, labeled MAINT. This port is used to detect if the external Maintenance Bypass Selector Switch is in the closed or open position/status. The closed position means that utility power is switched to be feed to the input of the UPS. The opened position means that all power has been removed from the UPS so it can be removed from the system to perform periodic maintenance. This port remains unconnected when no external Maintenance Bypass Switch is present in the system. The external Maintenance Bypass Switch is only supported on the 10to20kVA 3-Phase UPS Family

EPO Signal (7)

All units have an Emergency Power Off Signal Port, labeled EPO. This UPS comes equipped with a 2 pin plug wired to provide a short that results in normal UPS operation. Caution, if the plug is removed, The UPS system will be commanded to shut down. In typical applications, the plug will be removed, and the UPS will be wired to a remote source to provide a short for normal operation or open circuit to command the UPS to shut down.

USB Communication (USB or USB symbol) (8)

Factory interface port.

RS232 Communication (RS232) (9)

All units have a DB9 equipped with RS232 serial communications. This serial communications port provides basic monitoring and control.

Battery Temperature Sensor Port (BAT-T) (10)

For future use.

EBP Connection

All units have an External Battery Pack (EBP) power connection, labeled, 24VDV or 36VDC or 48VDC or 72VDC. Each UPS Model has been calibrated to a specific EBP

and EBP Operating Voltage and are not interchangeable due to the operating voltage.

Chassis Ground Connection Point (ground symbol) (15)

All units have a chassis ground connection that is used to ground the UPS chassis to the rack/cabinet. For safety reasons, the connection must be connected to the rack/cabinet ground.

Parallel Ports (PARALLEL 1, PARALLEL 2) (19)

All 3-Phase units only, have two (DB15) parallel connections (one male and one female). These connections are used to wire two to four UPS units of the same SKU in parallel. Two 10kVA UPS units connected in parallel can act as one 20kVA UPS unit. Parallel mode will be discussed later.

Dry Contacts (IN 1-8, OUT1-8) (20)

All 3-Phase units only, have eight input and eight output dry contact connections. Each dry contact port is across two dry contact connections (1 and 2, 3 and 4, 5 and 6, 7 and 8). These dry contact ports allow remote monitoring and control via switches and indicators.

Back Feed Contacts (BACKFEED 1-4) (21)

For future use.

Output Sensor Port (OUTPUT) (22)

All 3-Phase units only, have an output sensor port. This port is used to detect the status of the external Maintenance Bypass Switch (P/N UMB20K) Output Breaker. This port remains unconnected when no external Maintenance Bypass Switch is present in the system. Refer to the Maintenance Bypass Switch User's Manual for more details.

RS485 Port (RS485) (23)

All 3-Phase units only, have an RS485 port. This port is for future use.

Input Power Cord

Each UPS Model may have unique power input connector, labeled INPUT. Refer to the corresponding Product Specification Sheet for detailed definition.

Output Receptacles

Each UPS Model may have unique power output connector, labeled GROUP 1 or GROUP 2. The following sections defined typical output receptacles, however, refer to the corresponding Product Specification Sheet for latest detailed definition.

U05N11V/U05S11V

The 5kVA North American (NA) UPS unit has a permanently connected input power cord with an L6-30 plug. This unit has two groups of outlets. Group 1 (2x L6-30R) outlets are the main outlets that are not switchable, these outlets should contain the critical loads. Group 2 (2x L6-20R) are switchable outlets, these outlets should contain the non-critical loads. During battery backup mode these outlets may be turned off earlier to conserve battery capacity for the Group 1 outlets.

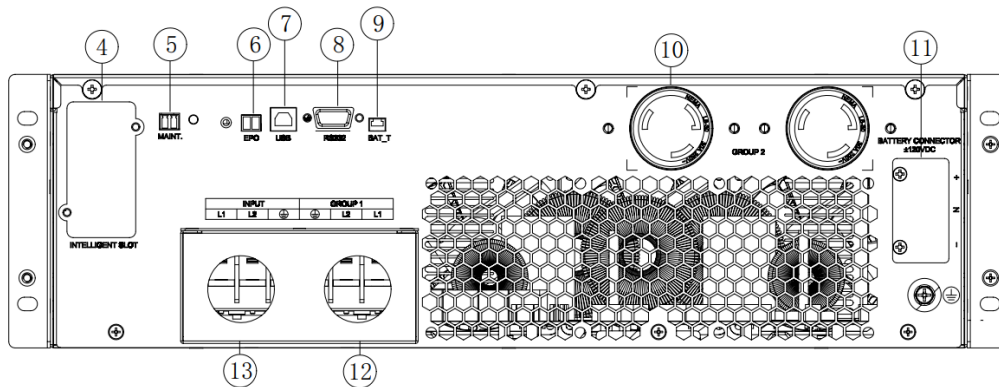

Figure 6: North American 5kVA Rear View (U05x11V)

U06N11V/U06S11V

The 6kVA NA UPS unit has a terminal block for a hardwire connection on the input of the UPS. This unit has two groups of outputs. Group 1 (hardwire connection) is the main non-switchable output; this output should contain the critical loads. Group 2 (2x L6-30R) are switchable outlets, these outlets should contain the non-critical loads. During battery backup mode these outlets may be turned off earlier to conserve battery capacity for the Group 1 output.

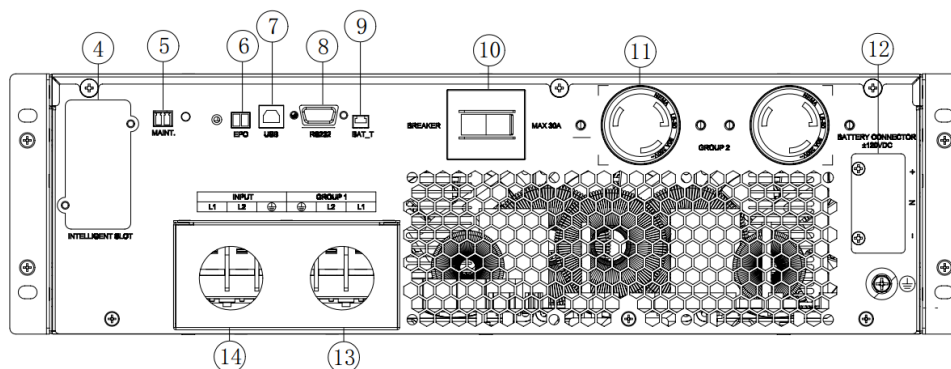

Figure 7: North American 6-10kVA Rear View (U06N11V / U06S11V)

U06N12V/U06S12V

The 6kVA EU UPS unit has a terminal block for a hardwire connection on the input of the UPS. This unit has three groups of outputs. Group 1 (hardwire connection) is the main non-switchable output; this output should contain the critical loads. Group 2 (2x C-13 with a 10A output breaker) are non-critical load switchable outlets. Group 3 (2x C-19 with a 16A output breaker) are non-critical load switchable outlets. During battery backup mode the Group 2 and Group 3 outlets may be turned off earlier to conserve battery capacity for the Group 1 output.

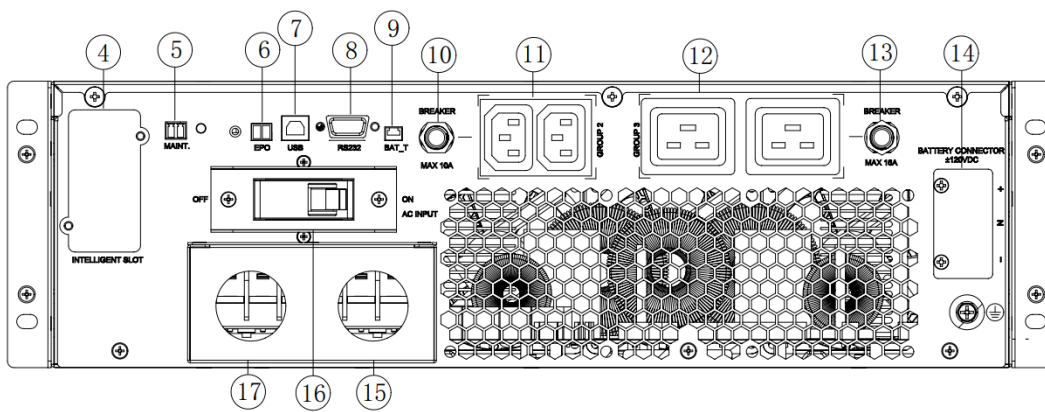

Figure 8: European 6-10kVA Rear View (U06N12V / U06S12V)

U10N11V/U10S11V

The 10kVA NA UPS unit has a terminal block for a hardwire connection on the input of the UPS. This unit has two groups of outputs. Group 1 (hardwire connection) is the main non-switchable output; this output should contain the critical loads. Group 2 (2x L6-30R) are non-critical load switchable outlets. During battery backup mode these outlets may be turned off earlier to conserve battery capacity for the Group 1 output.

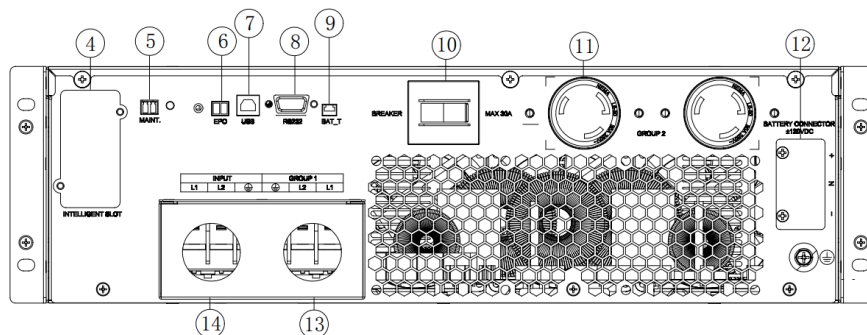

Figure 9: North American 10kVA Review View (U10N11V / U10S11V)

U10N12V/U10S12V

The 10kVA EU UPS unit has a terminal block for a hardwire connection on the input of the UPS. This unit has three groups of outputs. Group 1 (hardwire connection) is the main non-switchable output; this output should contain the critical loads. Group 2 (2x C-13 with a 10A output breaker) are non-critical load switchable outlets. Group 3 (2x C-19 with a 16A output breaker) are switchable outlets; these outlets should contain non-critical loads. During battery backup mode the Group 2 and Group 3 outlets may be turned off earlier to conserve battery capacity for the Group 1 output.

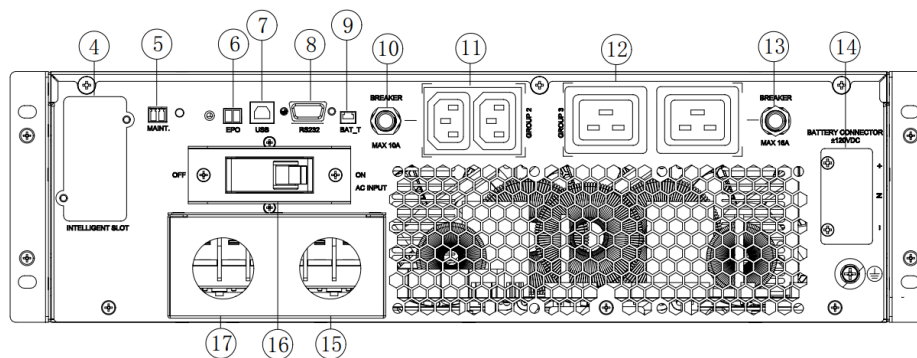

Figure 10: European 10kVA Rear View (U10N12V / U10S12V)

5-10kVA 1-Phase UPS Physical Feature Call Out Table:

1. Mounting Bracket	6. EPO	11. Group 2 Outlets
2. Status LEDs & LCD	7. USB	12. Battery Terminals
3. Power ON/OFF Button	8. RS232	13. Outlet Terminals
4. Intelligent Slot	9. BAT-T	14. Input Breaker
5. Maint. Bypass Signal	10. Group 2 Breaker	

U10N32V/U10S32V/U15N32V/U15S32V/ U20N32V/U20S32V

The 10 - 20kVA EU 3-phase UPS units have two groups of terminal blocks for a hardwire connection on the input of the UPS: one group for main input and the other group for bypass input. These units have one output group. The output is a hardwire connection and is non-switchable.

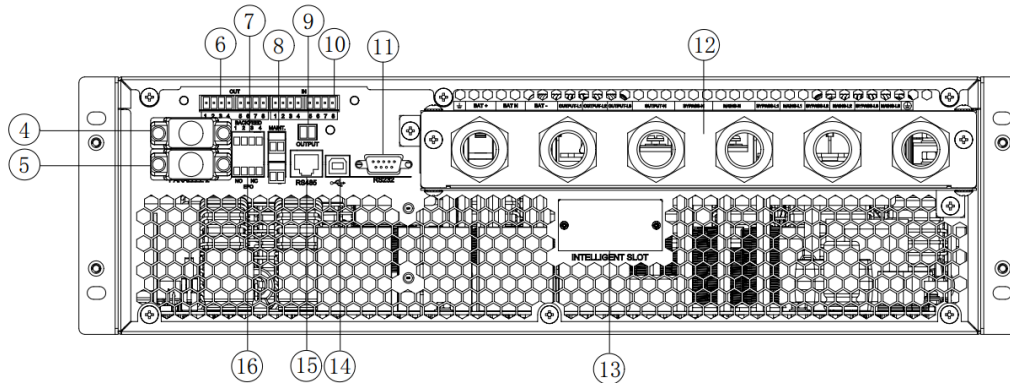

Figure 11: European 10-20kVA 3-Phase Rear View (U10x32V / U15x32V / U20x32V)

	BATTERY			OUTPUT				INPUT							
	BAT+	BAT N	BAT-	L1	L2	L3	N	BYPASS-N	INPUT-N	B1	L1	B2	L2	B3	

Figure 11B: 10-20kVA 3-Phase Input/Output/Battery Terminal Block

10-20kVA 3-Phase UPS Physical Feature Call Out Table:

1. Mounting Bracket	7. Back-feed protection port	13. EPO Terminal
2. Status LEDs & LCD	8. Maint. Bypass Signal	14. Intelligent Slot
3. Cold Start ON/OFF Button	9. Output Breaker Port	15. RS484
4. Parallel Port 1	10. Input Dry Contact Port	16. EPO
5. Parallel Port 1	11. RS232	
6. Output Dry Contact Port	12. In/Out/Bat Terminal Block	

UPS Options

External Battery Pack

The UPS comes with one External Battery Pack (EBP). Additional EBPs may be connect to the UPS to extend the runtime of the UPS when operating in battery mode. The single-phase 5-10kVA UPS units support up to five EBPs. The 3-phase 10-20kVA UPS units support up to eight EBPs.

The EPB has a positive-negative dual-battery structure. The single-phase 5-10kVA UPS units support a 240V battery pack. This battery pack has a total of 20 batteries connected in series. The 3-phase 10-20kVA UPS units support a 480V battery pack. This battery pack has a total of 40 batteries connected in series. In Figure 12 a neutral wire is drawn from the connection between the negative lead of the 10th (or 20th) battery and the positive lead of the 11th (or 21st) battery. A total of three wires are connected to the UPS unit, the positive and negative ends of the battery pack and a neutral line. The battery cartridge between the positive end of the battery pack and the neutral line of the battery pack is called a positive battery, and the battery cartridge between the negative end of the battery pack and the neutral line of the battery pack is called a negative battery. The positive and negative battery in series makes up the total EBP battery.

The BAT+ is connected to the positive lead of the positive battery, BAT-N is connected to the negative lead of the positive battery and the positive lead of the negative battery, and BAT- is connected to the negative lead of the negative battery.

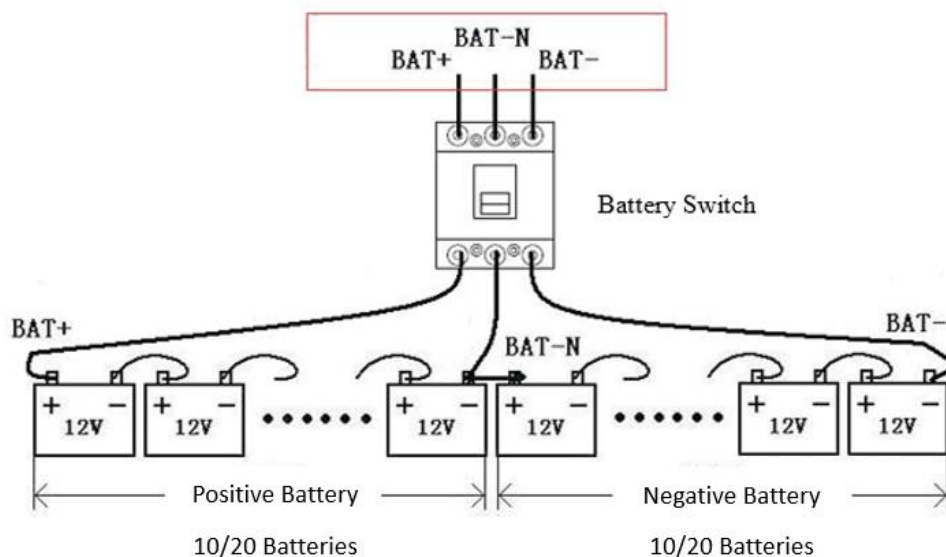

Figure 12: External Battery Pack Configuration

The factory setting for the number of batteries is preset to 20 or 40 depending on the EBP (P/N UVP240 or P/N UVP480). Note: When additional EBPs are connected to the UPS the number of EBPs must be appropriately set. All relevant settings may be performed through the WebUI or the Front Panel Display.

Warning!



Ensure that the polarities are correctly connected to the UPS unit and to subsequent EBP units. The battery cartridges cannot be mixed, please use the Panduit recommended battery cartridges sets (P/N UVD240 or P/N UVD480) for the appropriate EBP. Battery cartridges must be changed in sets. Do not mix old and new battery cartridges.

Maintenance Bypass Switch

The Maintenance Bypass Switch is an optional 3 RU unit that allows the 3-phase UPS unit to be removed from the system without powering down the load. The UPS has two sensor ports. The MAINT port allows the UPS to monitor the Maintenance Switch lock (on CB 3). The OUTPUT port allows the UPS to monitor the position of the output breaker (CB 4) in the Maintenance Bypass Switch unit.

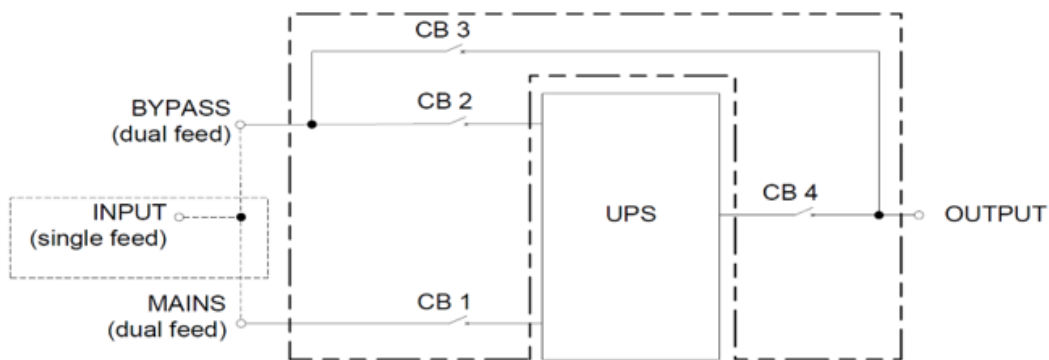

Figure 13: High-level Maintenance Bypass Switch Block Diagram

Network Card

The network card comes installed in the “N” type model UPS units (ex. U05N11V, U10N12V, U20N32V, etc.). Refer to Section 3 for monitoring and controlling the UPS through the Network card. The “S” type model UPS units (ex. U05S11V, U10S12V, U20S32V, etc.) may be upgraded with a network card or a relay card.



CAUTION! DO NOT TOUCH THE NETWORK CARD WITHOUT PROPER ESD PROTECTION.

Network Card Hardware Features

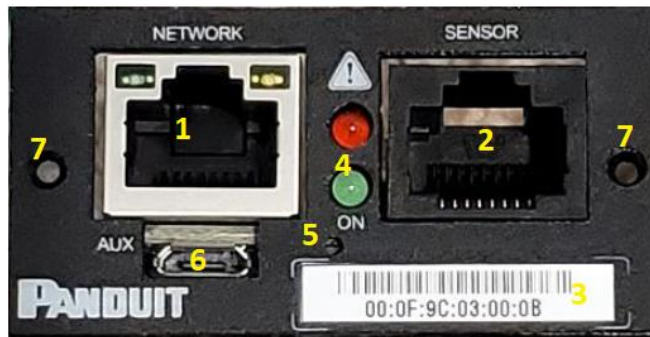

Figure 14: Network Card Front View

1. Ethernet Connection	3. MAC ID Label	6. Micro USB Connection
2. Sensor Connection	4. Status LEDs	7. Mounting holes
	5. Reset button	

Ethernet Connection

Connect the ethernet port on the Network card to an ethernet switch or router using a standard Cat 5E or Cat 6 ethernet cable.

Sensor Connection

Connect the supports Panduit environmental sensors and/or sensor hub with the cables provided in the sensor installation kit.

MAC ID Label

The MAC ID of the wired ethernet port is listed on the label on the faceplate of the Network card. The MAC ID is unique to the specific Network card.

Status LEDs

The red status LED turns on automatically as soon as power is applied. After the Network card initializes, the firmware in the Network card takes control of these LEDs. In general, the green LED indicates power to the Network card and the red LED indicates a fault on the Network card.

Reset Button

A pin hole is provided in the faceplate of the Network card to access the reset button

using a paper clip or similar device. The behavior of the Network card is provided in the table below and is dependent on the duration of the button press.

RESS DURATION	FUNCTION
>8 Seconds	Soft Reset to Restart/Reboot NMC
>20 Seconds	Hard Reset to Reset factory default settings of NMC

Micro USB Connection

The USB connector provides a COM port connection for a command line interface (CLI) to the Network card.

Relay Card

The intelligent slot on the UPS unit may accept the relay card or the Network card, not both. The relay card would typically not be used in the 3-phase UPS units since these units have dry contact points built into the unit. Follow the steps in the Network card section to install or remove the relay card from the UPS unit.

The 12-pin plus 2 terminal relay card allows the user to monitor specific status on the UPS and enable a remote UPS shutdown. The predefined monitoring contact points on the relay card change state when the status in the UPS changes state.

Terminal NO.	Terminal function	Description
1	Common source	common point for all contacts on the relay card
2	UPS ON = Open	When the UPS is switched ON, Pin 1 to Pin 2 would change from NC (Normal Closed) to Open.
3	AC fail = Open	When the input utility power fails, Pin 1 to Pin 3 would change from NC (Normal Closed) to Open.
4	AC fail = Close	When the input utility power fails, Pin 1 to Pin 4 would change from NO (Normal Opened) to Close.
5	Batt low = Open	When the battery voltage is low, Pin 1 to Pin 5 would change from NC (Normal Closed) to Open.
6	Batt low = Close	When the battery voltage is low, Pin 1 to Pin 6 would change from NO (Normal Opened) to Close.
7	UPS alarm = Open	When the UPS has an alarm, Pin 1 to Pin 7 would change from NC (Normal Closed) to Open.
8	UPS alarm = Close	When the UPS has an alarm, Pin 1 to Pin 8 would change from NO (Normal Opened) to Close.
9	Bypass active = Open	When the UPS is working in Bypass mode, Pin 1 to Pin 9 would change from NC (Normal Closed) to Open.
10	Bypass active = Close	When the UPS is working in Bypass mode, Pin 1 to Pin 10 would change from NO (Normal Opened) to Close.
11	UPS fault = Open	When the UPS has a fault, Pin 1 to Pin 11 would change from NC (Normal Closed) to Open.
12	UPS fault = Close	When the UPS has a fault, Pin 1 to Pin 12 would change from NO (Normal Opened) to Close.

The relay card contains eleven dry contact outputs plus common and one dry contact input plus ground. The input and outputs are factory programmed according to functions listed in the table below.



Figure 16: Relay Card Front and Top View (showing connection points)

Section 2 – Front Panel Display (FPD)

The front panel display contains four color icon LEDs, a 3.5-inch color touch screen display and a power ON/OFF button.

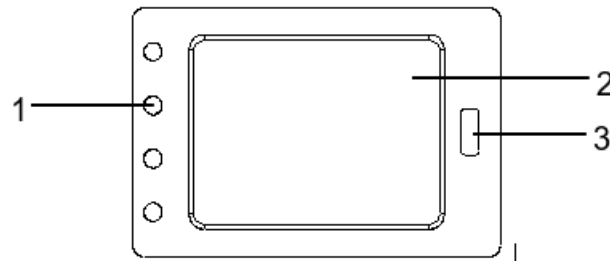

Figure 17: Front Panel Display (FPD)

1. Status LEDs (from top to bottom: Alarm, Bypass, Battery, Inverter)
2. Touch Screen Display
3. Power Button

Status LED Indicators

The status of the UPS system may be quickly identified through the following LEDs on the front panel display. The following table provides the descriptions of the four system LEDs.

Number	LED Icon	Description
1		Yellow: UPS alarm, Red: UPS fault
2		Blue: UPS is in bypass mode
3		Yellow: UPS is in battery mode
4		Green: UPS has AC input power

Power Button Operation

Button	Function
<p>ON/OFF Button</p>	<ul style="list-style-type: none"> ➤ Turn on UPS: ➤ Battery Mode: Press and hold the ON/OFF button for more than 6 seconds to turn OFF the UPS power. ➤ Exit bypass mode: When the UPS is in bypass mode, press and hold this button to switch to normal mode.

Turn On/Off UPS

Starting the UPS without an Optional Maintenance Bypass Switch:

- Set the Battery Breaker to the “ON” position.
- Ensure that all the Input and Output breakers on the UPS are in the “ON” position.
- Press and hold the ON/OFF button for more than 2 seconds to turn ON the UPS power.

Starting the 3-Phase UPS with an Optional Maintenance Bypass Switch Unit:



CAUTION! MAKE SURE GROUNDING IS PROPERLY CONNECTED!

- Set the Battery Breaker to the “ON” position.
- Turn ON BYPASS breaker and MAINS breaker.
- Turn ON OUTPUT breaker

If the Rectifier input is within voltage range, the rectifier will start up in 60 seconds followed by the inverter.

Switching to Bypass Mode:

- While the UPS is operating in Normal Mode, activate the internal mechanical bypass switch to switch to Bypass Mode.

- NOTE: The load is not protected, and the power is not conditioned by the UPS when the UPS is in internal Bypass Mode.

Switch the 3-Phase UPS to Maintenance Bypass (with the option Maintenance Bypass Switch Unit - MBS):

- Remove the cover over the Maintenance Switch breaker (on the optional MBS), the UPS automatically switches to bypass mode.
- Turn ON Maintenance breaker on the MBS.
- Switch OFF the Battery breaker on the EBP(s) connected to the UPS.
- Switch OFF Mains breaker on the MBS.
- Switch OFF BYPASS breaker on the MBS.
- Switch OFF OUTPUT breaker on the MBS.

At this point the UPS is isolated from the system and the MBS source is supplying power to the load through the Maintenance breaker.

Switch to Normal Operation from Maintenance Bypass through the MBS

Note: Never attempt to switch the UPS back to Normal Mode until it is verified that there are no internal UPS faults.

- Turn ON Output breaker on the MBS.
- Turn ON Bypass breaker on the MBS.
- Turn ON Mains breaker on the MBS.
- The UPS starts powering the load from the internal Bypass in parallel with the Maintenance Bypass and the bypass LED on the UPS will turn ON.
- Switch OFF the Maintenance Bypass breaker on the MBS, the load is fully supplied by the internal Bypass of the UPS.
- Replace the cover plate on the Maintenance Switch breaker.

The rectifier will start operating normally after 30 seconds. If the inverter is working normally, the system will automatically switch from Bypass mode to Normal mode.

Shutdown Procedure



CAUTION! This procedure should be followed to completely shut down the UPS and the LOAD. After all power switches, isolators and circuit breakers are opened, there will be no output.

- Switch OFF the Battery breaker on the EBP.
- Switch OFF the Mains breaker on the MBS. If there is no MBS, then this breaker must be switched OFF at the power distribution panel.
- Switch OFF the Bypass breaker on the MBS. If there is no MBS, then this breaker must be switched OFF at the power distribution panel (3-Phase UPS only).
- Switch OFF the Output breaker on the MBS. The UPS shuts down.
- To completely isolate the UPS from AC Input Mains, you either need a MBS unit that is operating in Maintenance Bypass mode or all input switches from the Utility shall be turned OFF and lockout tagout should be placed on the power distribution panel feeding the UPS.

Note: Wait for about 15 minutes for the internal D.C. bus bar capacitors to be completely discharged.

Display Operations

The display has several pages. There is home, status, alarm, setting, maintenance, common and unit informational pages that may be displayed on the Front Panel Display (FPD). This section describes the details of each page.

Menu Structure

5-10kVA Single-Phase UPS Menu Structure

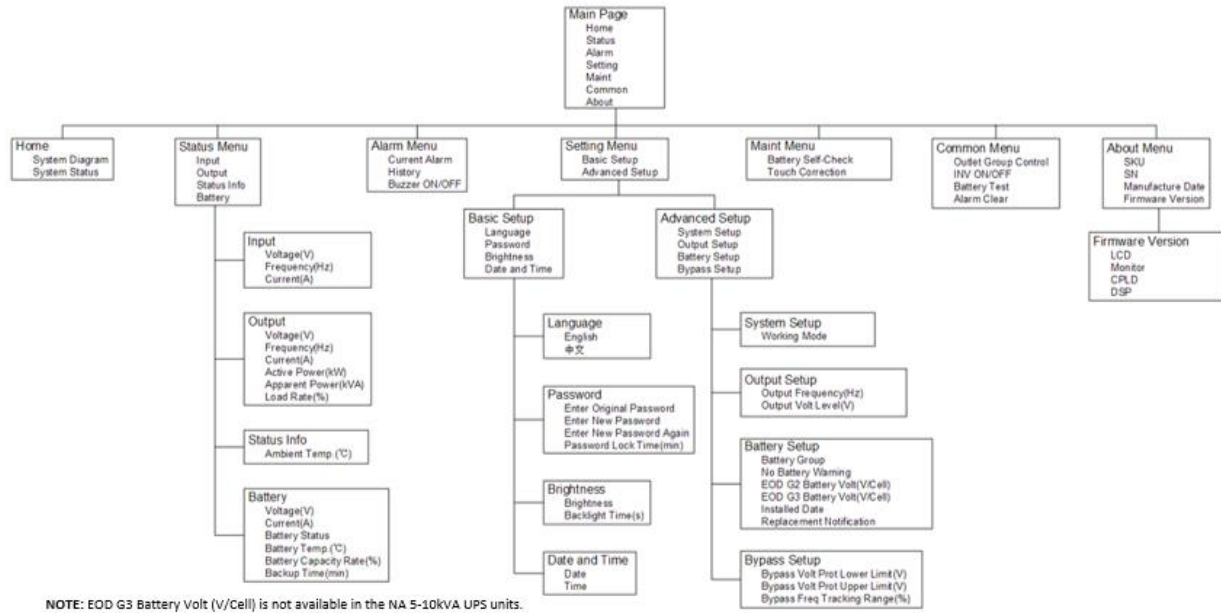

Figure 18: 5-10kVA Single-phase UPS Menu Structure

10-20kVA 3-Phase UPS Menu Structure

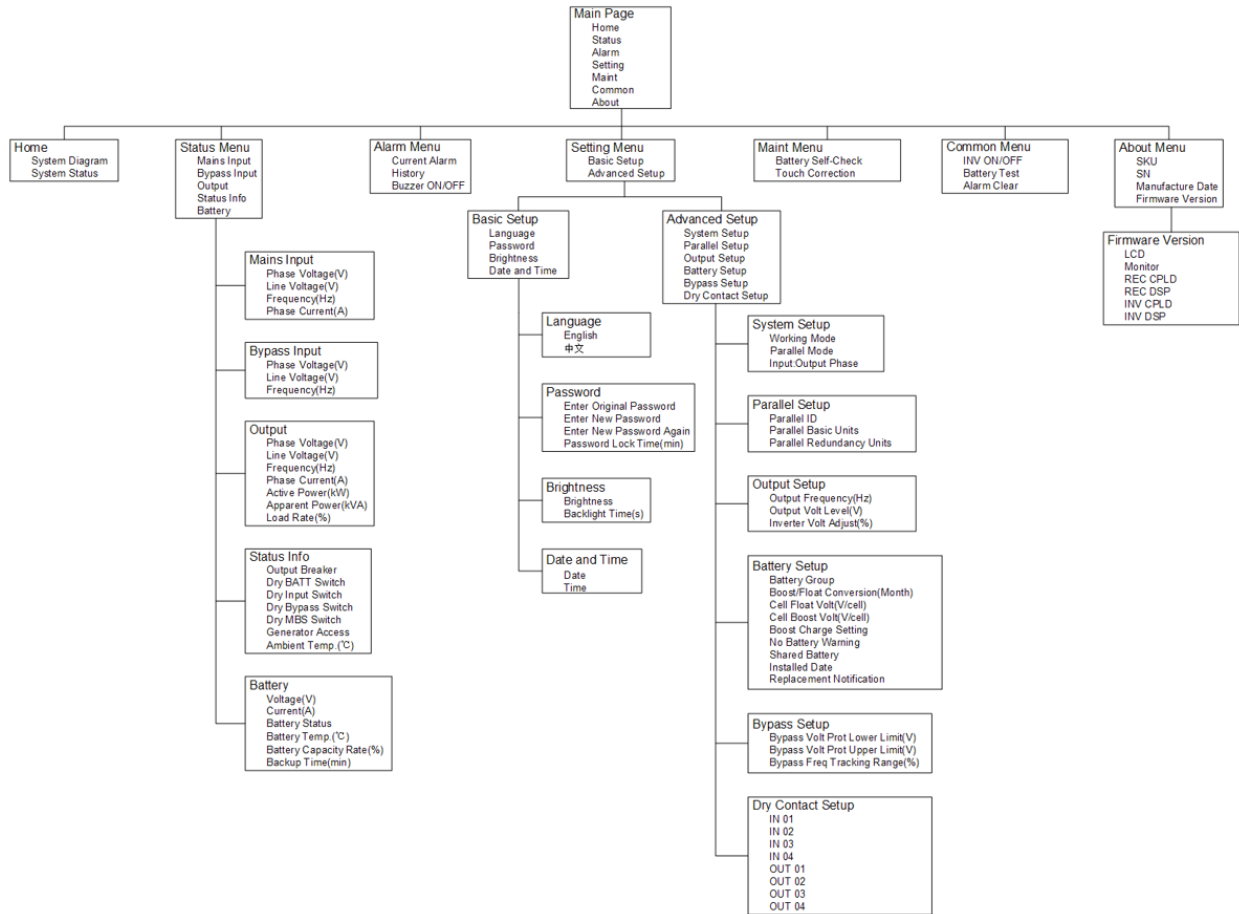

























Figure 19: 10 – 20kVA 3-Phase UPS Menu Structure

Display Icons

Number	Icon	Description
1		Status Icon: When pressed goes to the status menu page.
2		Alarm Icon: When pressed, goes to the alarm/warning/event menu page.
3		Warning Icon: When pressed, goes to the alarm/warning/event menu page.
4		Event Icon: When pressed, goes to the alarm/warning/event menu page.
5		AC Input Icon: Mains or Bypass input circuitry will turn green on the home page when active.
6		Rectifier Icon: AC to DC rectifier circuitry will turn green on the home page when active.
7		Inverter Icon: DC to AC inverter circuitry will turn green on the home page when active.
8		Bypass Icon: Bypass circuitry will turn green on the home page when active.

Number	Icon	Description
9		<p>AC Output Icon: Output circuitry will turn green on the home page when providing power to the load.</p>
10		<p>Load Icon: The approximate load capacity percentage is indicated by the number of load bar sections illuminated. Each bar represents 25% of the load capacity.</p>
11		<p>Battery Charge Status: Indicates the battery charge status. Each incremental 25% bar is solid ON when charged or will blink ON and OFF when charging.</p>
12		<p>Mute Icon: Indicates the audible alarm is disabled, muted.</p>
13		<p>Next Icon: When pressed, goes to next page.</p>
14		<p>Previous Icon: When pressed, goes to previous page.</p>
15		<p>Return Icon: When pressed, returns to menu page in that category.</p>
16		<p>Home Icon: The home</p>

Number	Icon	Description
		icon provides an overview of the UPS with access to the Dashboard, Identification, and Control & Manage.
17		Dashboard Icon: When pressed, goes to the dashboard page.
18		Status Icon: When pressed, goes to the status menu page.
19		Alarm Icon: When pressed, goes to the alarm/warning/event menu page.
20		Settings Icon: When pressed, goes to the settings menu page.
21		Maintenance Icon: When pressed, goes to the maintenance menu page.
22		Common Icon: When pressed, goes to the common menu page.
23		About Icon: When pressed, goes to the about menu page.
<p>Note: The icons on the front panel display may vary depending on the installed firmware version.</p>		

Initialization Page

As the UPS unit powers up and initializes the FPD will show the Smartzone UPS initialization page, refer to Figure 20.



Figure 20: UPS Initialization Page on the Front Panel Display

Home Pages

After initialization is complete, the FPD automatically transitions to the home page. This is a summary page that provides a quick view of the UPS current operating conditions. This page also allows the user quick access other pages in the FDP.

The home page has two pages, the first page provides the system status with a block diagram of the current working mode. The second page provides more information on the input and output measurements, on the charged capacity of the battery, on the battery runtime, on the current output active and apparent power, and on the current load connected to the UPS.

Home Page

The home page contains all the key information that the user needs for a quick view of the operating status of the UPS system, refer to Figures 21 and 22. Figure 21 is representative of all 5-10kVA Single-Phase UPS units. Figure 22 is representative of all 10-20kVA 3-Phase UPS units.

The dark blue banner along the top of the page provides the KVA of the unit, the system working mode, and the date and time that is set in the system. The figures show 10kVA, Normal Mode, 2022-01-01 and 07:00:00 for the above parameters.

The light blue banner near the top of the page is the secondary banner that provided

system status and allows the user to transition to other FPD pages. Pressing the three horizontal bars takes the user to a Status Menu page, refer Figure 23. For a functioning UPS unit, the Mains State will be replaced with the current operating state (Status/Alarms/Events) of the UPS. Pressing on the Login location allows the user to login to the UPS with specific credential that were previously entered into the system. The three icons and numbers to the left of the Login are the current Alarms, Warnings and Events on the system. Pressing on this location transitions the FPD to the Alarm Menu page, refer to Figure 33.

The remainder of the page provides a block diagram of the system, highlighting the current UPS working mode. The examples in Figures 21 and 22 show the UPS in normal mode (on-line double conversion mode). Main AC power is feed to the rectifier to convert to DC power. The output of the rectifier charges the battery and provides power to the inverter. The inverter converts the DC power back to AC power to provide a pure AC sinewave at the specified frequency to the output. Pressing on the Mains, Bypass, Battery, or Output block is a shortcut to the detailed page for that function.

Also shown on this part of the page is the measured input and output AC voltages. Figure 21 shows an input and output voltage of 230V for the European (EU) Single-Phase unit and Figure 22 shows 400V for the EU 3-Phase unit. There is also a load icon above the Output block that indicates the load capacity that is currently connected to the UPS, in increments of 25%. Figure 21 and 22 shows the UPS is 100% loaded (25% is shown for loads from 0% to 25%, 50% is shown for loads of 26% to 50%, etc.). Under the Output are the outlet groups. When an outlet group is providing power (turned ON), it will be shown on the page. If the outlet group is not providing power (turned OFF), that outlet group will not be present on the page.

From the home page in Figure 21 and 22 the down arrow transitions to the dashboard page (refer to Figure 23) and the up and over arrow transitions to the Status Menu page (refer to Figure 24).

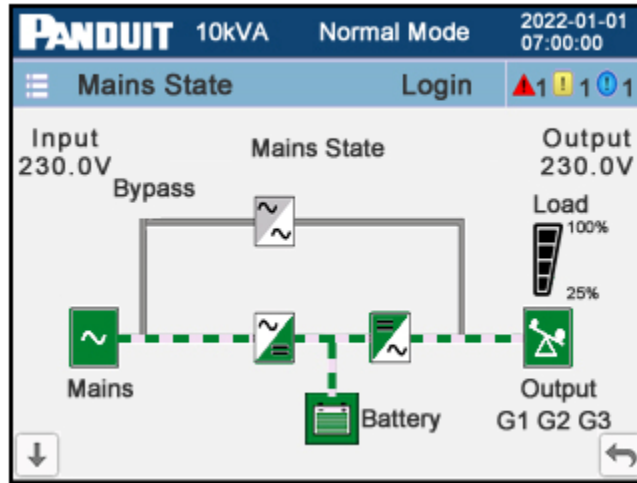

Figure 21: 5-10kVA Home Page (EU Single-Phase UPS)

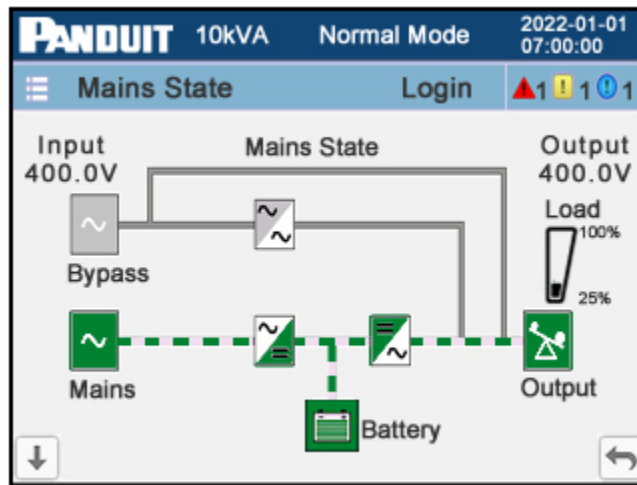

Figure 22: Home Page (3-Phase UPS)

Dashboard Page

This page has the same two banners across the top of the page as the Home page.

The main body of the Dashboard page is broken up into categories. On the left side of the page are the input measured parameters, voltage and current of each phase. On the right side of the page are the output measured parameters, voltage and current of each phase and output frequency. For single phase units only one measured value will be in each category.

Press the up arrow to go back to the previous page. Press the up and over arrow to return to the home page. Press the HOME icon returns to the home page. In this case, all three presses will return to the same page, Home page.

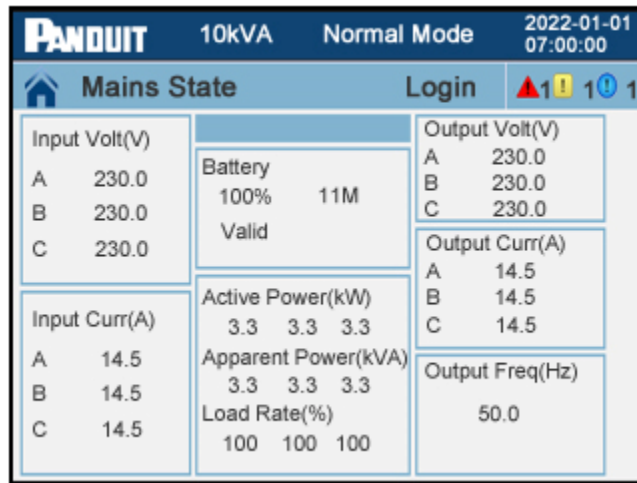

Figure 23: Dashboard Page (3-Phase UPS)

Status Pages

The status page has ten pages, the first page provides a menu of the status pages. The second page provides details on the measured input (main) values. The next page provides details on the measured bypass values. The next two pages provide details on the measured output values. The next two pages provide details on the measured battery values. The final three pages provide information about the status of the UPS interfaces.

Status Menu Page

This is a menu page for four or five groups of status pages. The dark blue banner along the top of the page provides the KVA of the unit, the UPS system working mode, and the date and time that is set in the system.

The light blue banner near the top of the page is the secondary banner that allows the user to transition to other FPD pages. Pressing the house takes the user back to the home page, refer Figure 21 or 22. For a functioning UPS unit, the Mains State will be replaced with the current operating state (Status/Alarms/Events) of the UPS. Pressing on the Login location allows the user to login with specific credential that were previously entered into the system. The three icons and numbers to the left of the Login are the current Alarms, Warnings and Events on the system. Pressing on this location transitions the FPD to the alarm menu page, refer to Figure 33.

The main body of this page has four or five levels that may be pressed to transition the FPD to the detailed status pages.

The dark blue banner along the bottom of the page provides quick links to transition to

the Dashboard page (magnifying glass), Status Menu page (right/left arrows), Alarm Menu page (bell), Settings Menu page (gear wheel), Maintenance Menu page (hand tools), Common Menu page (hand touch point), or the About page (question mark sheet). Note: A small green “+” sign is next to the icon of the page type that the screen is currently in. In the below example the small green “+” sign is next to the status icon.

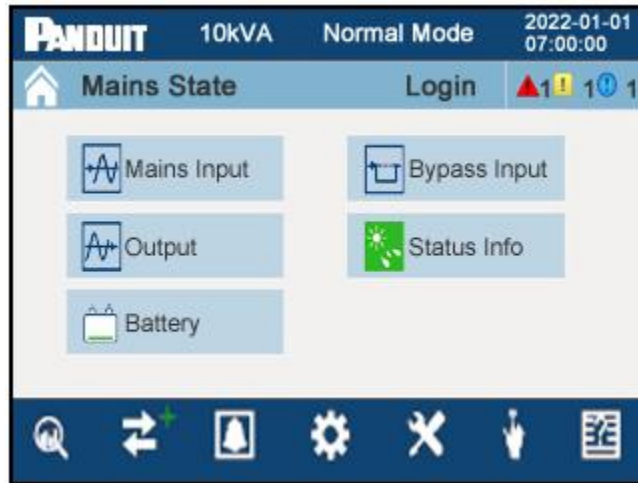

Figure 24: Status Menu Page

Mains Input Status Page

This page provides detailed input measurements. This page has the same two banners across the top of the page as described in the main menu page.

The main body of the page contains the input line to neutral voltage for each phase, the input line to line voltage for each phase, the input frequency for each phase, and the input current for each phase. The following figure is a sample page of a 3-phase UPS unit. For the single-phase units, no Line Voltage will be provided and only one measurement is shown on each of the other lines.

Press the up and over arrow to return to the Status Menu page.

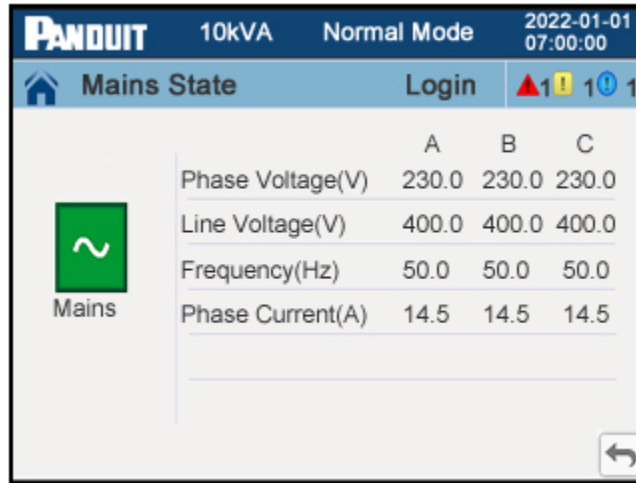

Figure 25: Mains Input Status Page (3-Phase UPS)

Bypass Input Status Page

This page provides detailed bypass input measurements, this page is supported only on the 3-phase UPS units where the mains inputs and the bypass inputs may be two separate connections. This page has the same two banners across the top of the page as described in the main menu page.

The main body of the page contains the bypass line to neutral input voltage for each phase, the bypass line to line input voltage for each phase and the bypass input frequency for each phase. The following figure is a sample page of a 3-phase UPS unit. For the single-phase units, this page will not be shown.

Press the up and over arrow to return to the Status Menu page.

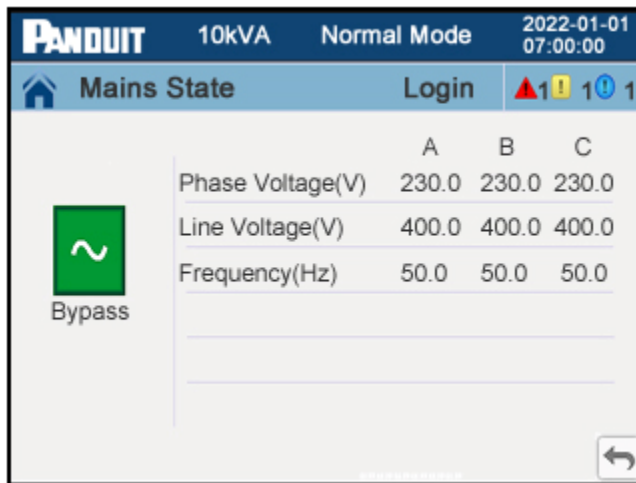

Figure 26: Bypass Status Page (3-Phase UPS)

Output Status Page

These two pages provide detailed output measurements. Both pages have the same two banners across the top of the page as described in the main menu page.

The main body of the first page contains the first four measured output parameters. The page shown below provides the output phase voltage for each phase, the output line-to-line voltage for each phase, the output frequency for each phase and the output current for each phase. The following figure is a sample page of a 3-phase UPS unit. For the single-phase units, the line-to-line Voltage will be provided so active power will move up from the second page and be displayed on this page, also only one measurement is shown on each of the lines.

Press the down arrow to go to the next output page. Press the up and over arrow to return to the Status Menu page.

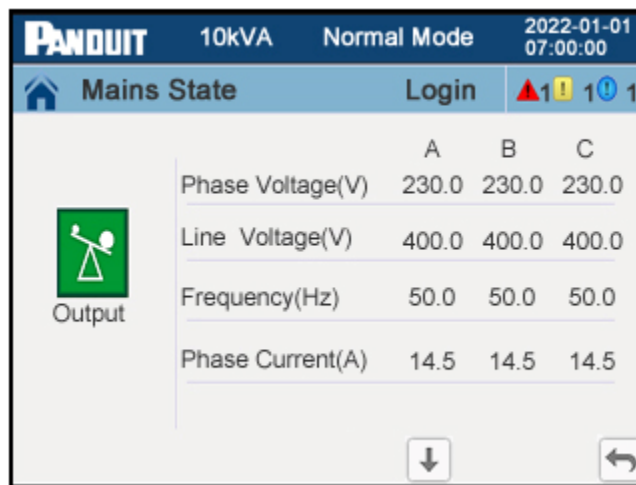

Figure 27: Output Status Page 1 (3-Phase UPS)

The main body of the second page contains the output active power for each phase, the output apparent power for each phase, and the output load rate for each phase. The following figure is a sample page of a 3-phase UPS unit. For the single-phase units, the active power moved up to the first page, so this page will only output apparent power and output load rate, also only one measurement is shown on each of the lines.

Press the up arrow to go to the previous output page. Press the up and over arrow to return to the Status Menu page.

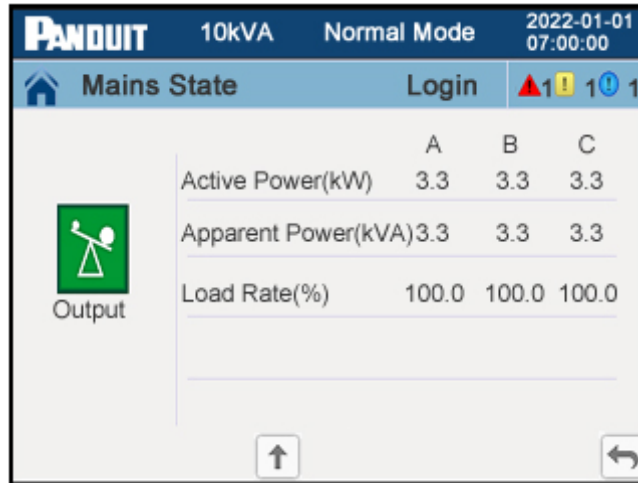

Figure 28: Output Status Page 2 (3-Phase UPS)

Status Information Page

These two pages provide the status of the Maintenance Bypass switches, the status of the dry contact ports built into the UPS, the status of a generator connection and the measured ambient temperature. Both pages have the same two banners across the top of the page as described in the main menu page.

Status Information Page 1

The main body of the first page contains status of the output breaker in the Maintenance Bypass Switch unit and the status of three dry contact points (battery switch, input switch and bypass switch). The MBS output breaker is sensed through the OUTPUT sensor port on the back of the UPS. The other three dry contacts are provided as monitoring point through dry contact ports on the back of the UPS. As noted in Section 1, these ports are only supported on the 3-phase UPS units. Therefore, all single-phase UPS units will not show this page.

Press the down arrow to go to the next Information Status page. Press the up and over arrow to return to the Status Menu page.

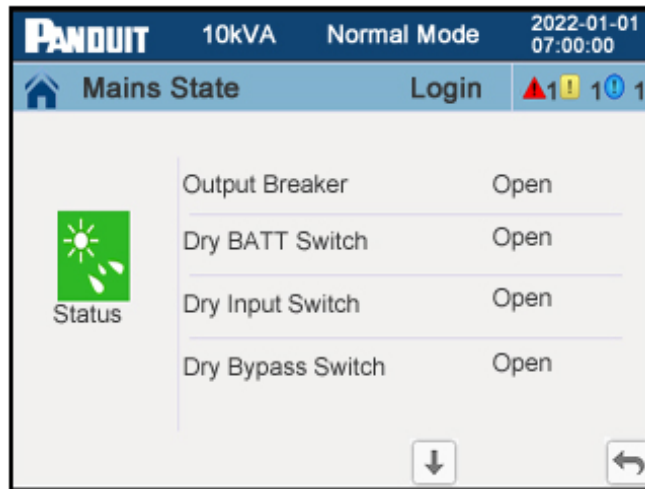

Figure 29: Status Information Page 1 (3-Phase UPS)

[Status Information Page 2](#)

The main body of the second page contains status of the lock plate over the maintenance bypass breaker in the Maintenance Bypass Switch unit, the status of the generator dry contact points and the ambient temperature detected by the UPS. The Maintenance Bypass Switch unit’s MBS switch is sensed through the MAINT sensor port on the back of the 3-Phase UPS unit. The Dry MBS Switch contact indicates if the locking plate is covering or not covering the bypass breaker in the Maintenance Bypass Switch unit. If the plate is removed this contact point will change to “Close”, meaning the UPS could be switched out of the system. When there is no Maintenance Bypass Switch unit in the system, the status of this switch will be “Open”.

The Generator Access point is sensed through an IN dry contact port on the back of the 3-Phase UPS. The Generator Access field is available only on the 3-phase UPS units that have built in dry contact points. When a generator is connected to the 3-phase UPS the generator feedback must be connected to an IN dry contact point on the back of the UPS and this contact point must be configured to Generator (see Advanced Settings).

The Ambient Temperature at the input side of the UPS (where the air enters the UPS from the cold aisle) is measure with a temperature sensor and displayed on this page. This is the only Status Page and the only information shown on the Status Page for the single-phase 5-10kVA UPS units.

Press the up arrow to go to the previous Status Information page. Press the up and over arrow to return to the Status Menu page.

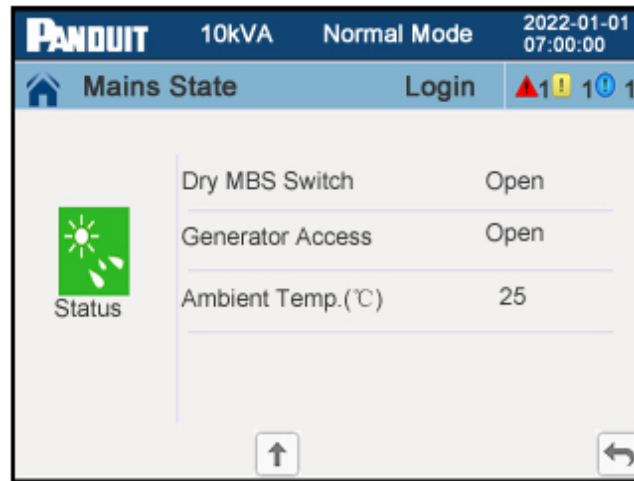

Figure 30: Status Information Page 2 (3-Phase UPS)

Battery Status Page

These two pages provide the status of the battery connected to the UPS. NOTE: All references to battery in this section refers to all EBP units connected to the system as one battery. Both pages have the same two banners across the top of the page as described in the main menu page.

Battery Status Page 1

The main body of the first page contains the battery voltage, battery current, battery status and the ambient temperature in the first connected EBP unit. NOTE: The voltage, current and status is shown for the positive battery and the negative battery as described in Section 1 of this document. The overall battery voltage and current is sum of the two absolute numbers. NOTE: It is assumed that all EBP units connect to the UPS are in the same environment so the battery temperature on this page is the battery temperature in the first EBP connected to the UPS. It is required to have a connection from the first EBP to the “BATT-T” port on the back of the UPS to get valid readings in this field.

Press the down arrow to go to the next battery page. Press the up and over arrow to return to the Status Menu page.

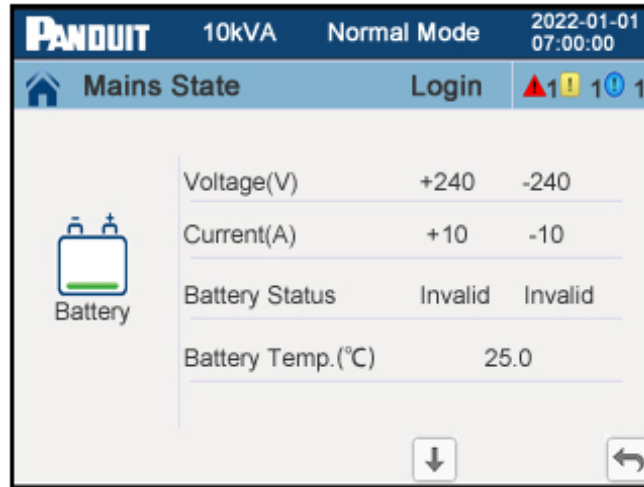

Figure 31: Battery Status Page 1

[Battery Status Page 2](#)

The main body of the second page contains status of the Battery capacity as a percentage of the maximum capacity and the battery backup time in minutes.

Press the up arrow to go to the previous Battery Status page. Press the up and over arrow to return to the Status Menu page.

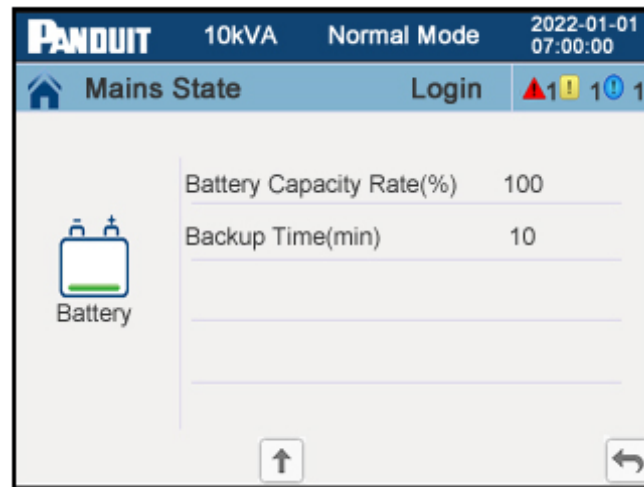

Figure 32: Battery Status Page 2

Alarm Pages

The alarm page has three plus pages, the first page provides a menu of the alarm pages. The second set of pages provide a list of the active alarms/warnings. The next set of pages provide a log of the historical events that occurred in the system.

Alarm Menu Page

This is the menu page for the alarm pages. This page has the same two banners across the top of the page and the same banner along the bottom of the page as described in the Status Menu page.

The main body of this page has two levels that may be pressed to transition the FPD to the alarm/warning page or the event log page. The third location is to mute or unmute the audio alarms on the UPS.

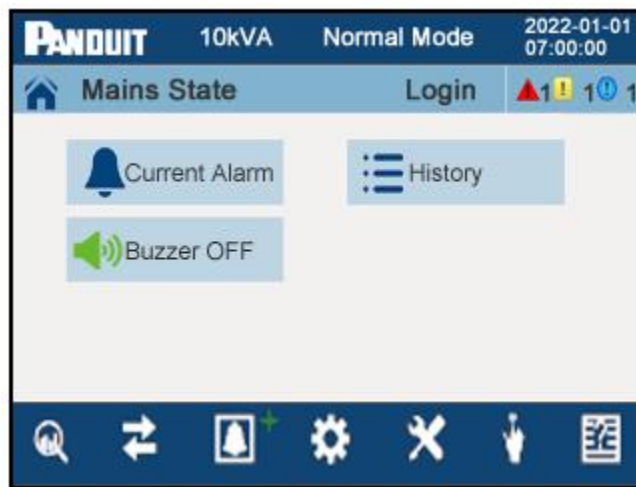

Figure 33: Alarm Menu Page (Audio ON)

Current Alarm Page

This page provides a list of the alarms and warnings that are currently active in the system. The most recent alarm/warning is at the top of the list. Alarms are identified by the red alarm icon and warnings are identified by the yellow warning icon. Each entry also includes an alarm/warning code, a short description and the location where the fault occurred. When the alarm/warning is cleared it will be recorded in the Event log.

Press the up arrow to scroll up in the list. Press the down arrow to scroll down in the list. Press the up and over arrow to return to the Alarm Menu page.

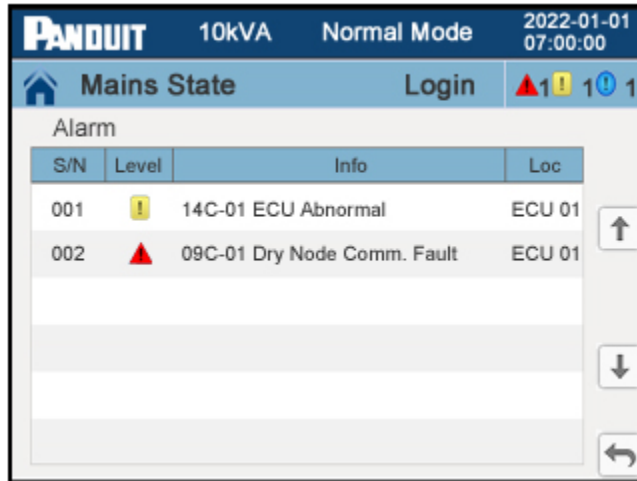

Figure 34: Current Alarm Page

History Event Page

This page provides the log of events that have happened in the UPS system. The most recent event is at the top of the log. Alarms are identified by the red alarm icon; warnings are identified by the yellow warning icon and events are identified by the blue event icon. Each entry also includes a short description, the location where the event occurred and a date/time stamp when the event occurred.

Press the up arrow to scroll up in the log. Press the down arrow to scroll down in the log. Press the up and over arrow to return to the Alarm Menu page.

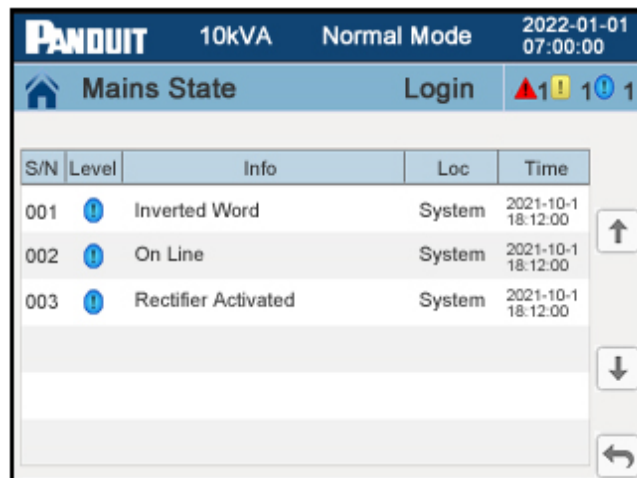

Figure 35: Event Log Page

Buzzer Mute

Pressing the Buzzer OFF location on the Alarm Menu page mutes or unmutes the audio

alarms in the UPS. The audio alarm location toggles between mute and unmute every time it is pressed. When the audio is unmuted, this location will have a green speaker icon as shown in Figure 33, when the audio is muted, this location will have a red speaker icon, refer to Figure 36.

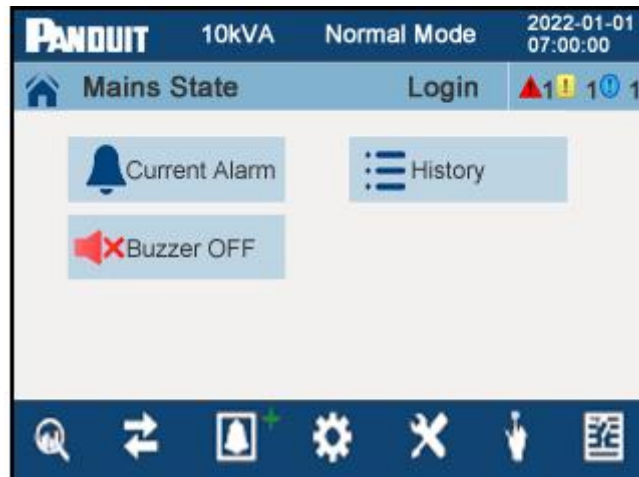

Figure 36: Alarm Menu Page with Audio OFF

Setting Pages

There are several setting pages, the first page provides a menu of the two setting page levels. Setting pages are used to configure the UPS. The basic setting page is not password protected; however, the advanced setting pages are password protected.

Setting Menu Page

This is the menu page for the UPS setting pages. This page has the same two banners across the top of the page and the same banner along the bottom of the page as described in the Status Menu page.

The main body of this page has two levels that may be pressed to transition the FPD to the Basic Setting pages or the Advanced Setting pages. Pressing on the Basic Setting level will transition the FPD to the Basic Setting menu page. Pressing on the Advanced Setting level will transition the FPD to the Password Entry page (if the user is not already logged in with the proper credentials), where the appropriate password must be entered to continue to the Advanced Setting menu page.



Figure 37: Setting Menu Page

[Basic Setting Menu Page](#)

This is the menu page for the basic settings. This page has the same two banners across the top of the page and the same banner along the bottom of the page as described in the Status Menu page.

The main body of this page has four levels that may be pressed to transition the FPD to the various basic setting pages. From this page the user may transitions to the pages that change the display language, the login password, the display brightness, or the system’s date and time.

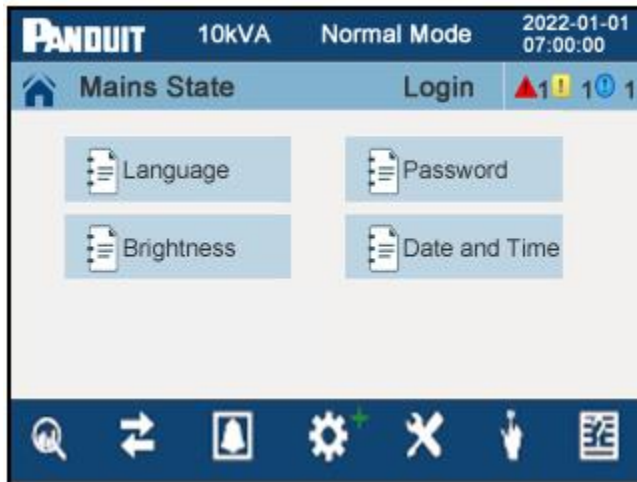

Figure 38: Basic Setting Menu Page

[Language Setting Page](#)

This page allows the user to set the language to be shown on the display. This page

has the same two banners across the top of the page as described in the Status Menu page.

The main body of this page has left and right arrows on the Language line to scroll through the available language options supported on the UPS, the default is English. After selecting the appropriate language, press the “Save Config” button to save this language to be shown on the display.

Press the up and over arrow to return to the Basic Setting Menu page.

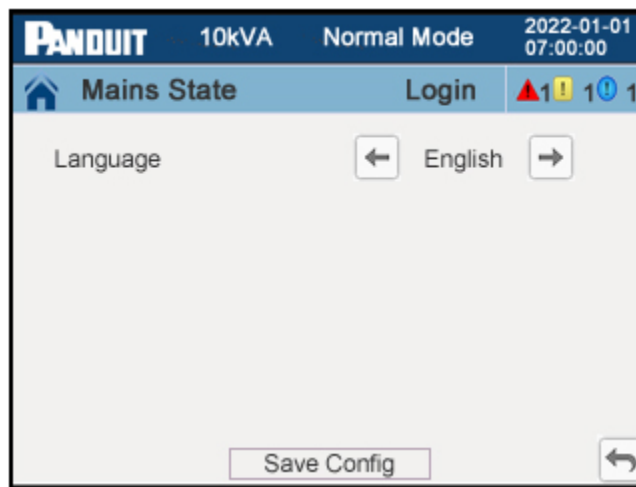

Figure 39: Language Setting Page

[Password Setting Page](#)

This page allows the user to change passwords and password lock out times on the system. This page has the same two banners across the top of the page as described in the Status Menu page.

The main body of this page has three password entry boxes for entering the current password and then entering the new password twice. The default password is “123456”. It is recommended to change this password as soon as possible for security reasons.

Pressing on the password entry box will transition the FPD to the Password Keyboard page. On the Password Keyboard page enter the appropriate old password and press the “OK” button. The user must enter the appropriate information into all three password entry boxes for the new password to take effect. Complete the new password entries the same way. NOTE: Password format is six numbers. Under the password entry boxes are left and right arrows on the “Password Lock Time” line to scroll to the desired time in minutes. The user will be forced out of the login if there has been no activity on the Display for the number of minutes specified in this line.

After making all the necessary changes on this page, press the “Save Config” button to save the password changes.

Press the up and over arrow to return to the Basic Setting Menu page.



Figure 40: Password Setting Page

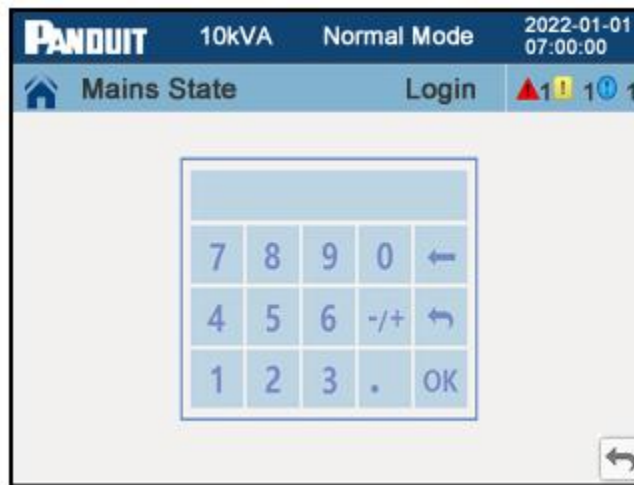

Figure 41: Password Keyboard Page

Brightness Setting Page

This page allows the user to set the brightness and timeout on the display. This page has the same two banners across the top of the page as described in the Status Menu page.

The main body of this page has two lines, one for display Brightness and one for Backlight Timeout. On the “Brightness” line press on the number to enter a new number

from 1 to 63 to change the brightness of the display, the default is 63.

On the “Backlight Time” line the user may enter a number from 1 to 255 seconds, the default is 60 seconds. This is the number of seconds that the display will stay light with no activity before turning OFF to conserve power.

After making all the necessary changes on this page, press the “Save Config” button to save the changes.

Press the up and over arrow to return to the Basic Setting Menu page.

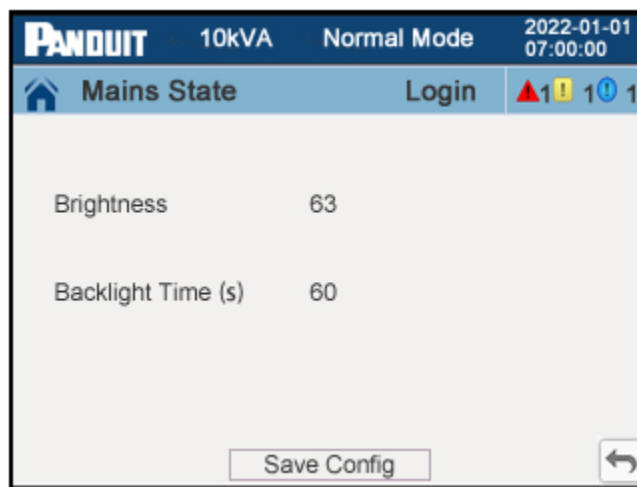

Figure 42: Brightness Setting Page

[Date and Time Setting Page](#)

This page allows the user to set the date and time in the UPS. This page has the same two banners across the top of the page as described in the Status Menu page.

The main body of this page has two lines, one for Date and one for Time. On the “Date” line press on the date field to enter the Year, Month, and Day in the following format, YYYY-MM-DD.

On the “Time” line press on the time field to enter the Hour (24 hour format), Minute and Second in the following format, HH:MM:SS. This date and time will be shown at the top of all pages and is used to timestamp the event log and for running periodic tests.

After making all the necessary changes on this page, press the “Save Config” button to save the changes.

Press the up and over arrow to return to the Basic Setting Menu page.

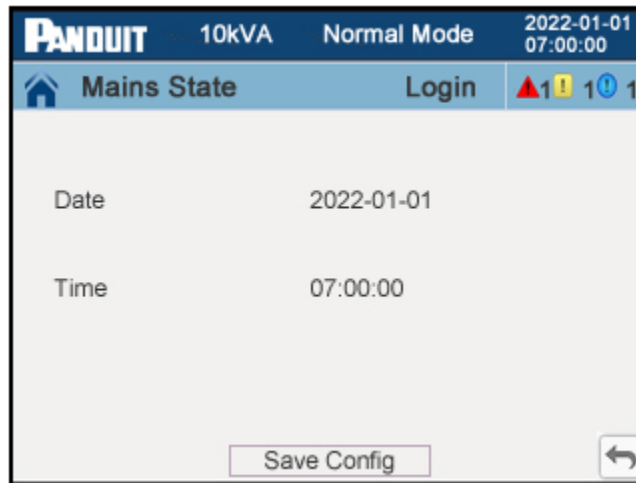

Figure 43: Date/Time Setting Page

[Advanced Setting Menu Page](#)

NOTE: These operations are recommended to be performed by professional service providers, or under the guidance of professional service providers.

From the Setting Menu page, pressing on the Advanced Settings level will transition the FPD to the Password Entry page, if the user was not already logged in with the proper credentials. NOTE: It is recommended to change the default password for security reasons. Change this default password on the Password Setting Page from the Basic Setting Menu page.

[Password Entry Page](#)

This is the Password Entry page that appears when attempting to access the advanced setting pages. This page has the same two banners across the top of the page and the same banner along the bottom of the page as described in the Status Menu page.

The main body of this page has a password entry box. Pressing on the password entry box transitions the FPD to the Password Keyboard page.

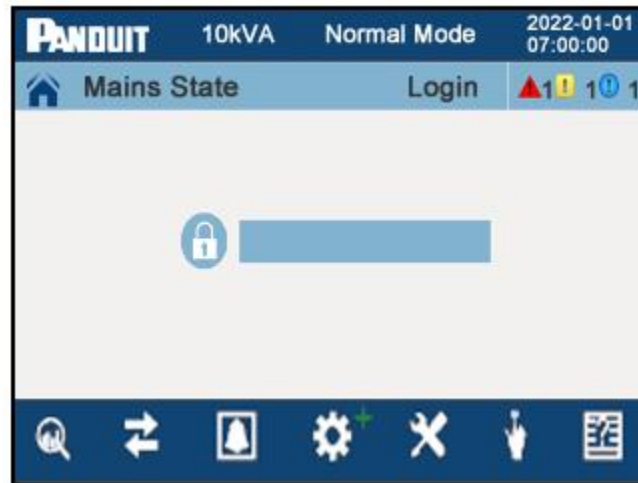

Figure 44: Password Entry Page

Password Keyboard Page

This is the Password Keyboard page that allow the user to enter the appropriate password. This page has the same two banners across the top of the as described in the Status Menu page.

The main body of this page has a number keyboard. Enter the appropriate password and press the “OK” button; this will transition the FPD back to a modified password entry page, the password entry box will have six “Stars” and a Login button will appear under the box. Pressing on the Login button logs the user into the UPS and transitions the FPD to the Advanced Setting Menu page. The default password for the Advance Setting pages is “123456”. NOTE: It is recommended to change the default password for security reasons. Change this default password on the Password Setting Page from the Basic Setting Menu page.

Once logged in, the Login location in the light blue banner along the top of the page will show the word “Exit”. The user will stay logged in until the login has timed out or until the user presses on this Exit location.

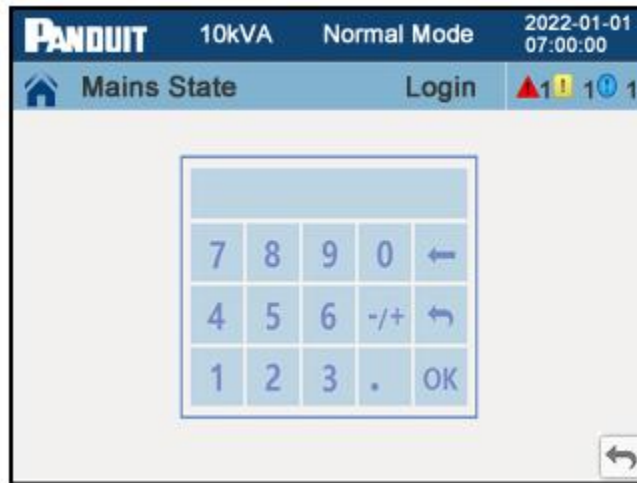

Figure 45: Password Keyboard Page

The Advanced Setting menu page has the same two banners across the top of the page and the same banner along the bottom of the page as described in the Status Menu page.

The main body of this page has four (for single-phase UPS units) or six (for 3-phase UPS units) levels that may be pressed to transition the FPD to the various advanced setting pages. From this page the user may transition to the pages that set the system parameters, set the parallel mode parameters, set the output parameters, set the battery parameters, set the bypass parameters, or set the dry contact parameters. Since the single-phase UPS units do not support parallel mode and do not have dry contact ports built in, these two levels do not exist on the single-phase Advanced Setting Menu page.

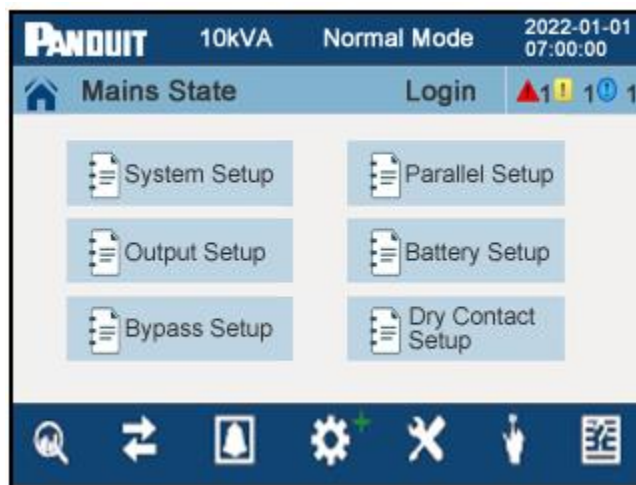

Figure 46: Advanced Setting Menu Page

System Setting Pages

These pages allow the user to set the system parameters of the UPS. These pages have the same two banners across the top of the page as described in the Status Menu page.

System Setting Page 1

This page allows the user to select the working mode, set the system configuration and select the input: output phase of the UPS. This page has the same two banners across the top of the page as described in the Status Menu page.

The main body of this page has three lines, one for working mode, one for the system configuration and one for input:output phases.

On the “Working Mode” line press on the left or right arrows to select Normal, Energy Saving (ECO), Convert Frequency (CF) or Generator (Gen) working mode, default is Normal mode.

On the “System Configuration” line press on the left or right arrows to select Single or Parallel mode, default is Single mode. Parallel mode is an option only on the 3-Phase UPS units. This line is not present on the 5-10kVA single-phase UPS units.

On the “Input:Output Phase” line press on the left or right arrows to select 3:3 or 3:1, default is 3:3. Three Phase in and three phase out or three phase in and single phase out is an option only on the 3-Phase UPS units. This line is not present on the 5-10kVA single-phase UPS units.

After making all the necessary changes on this page, press the “Save Config” button to save the changes.

Press the up and over arrow to return to the Advanced Setting Menu page.

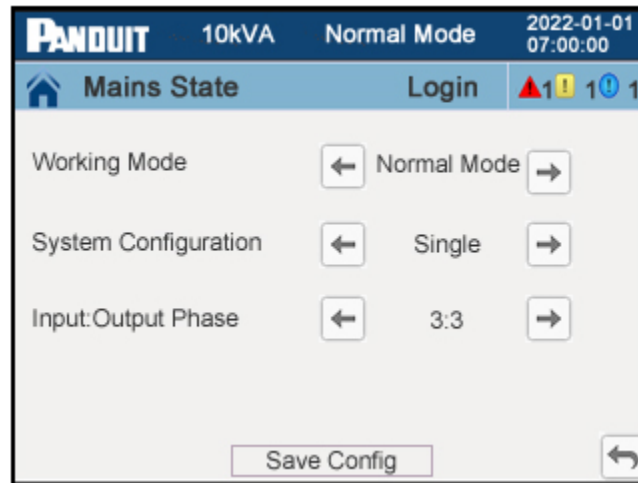

Figure 47: System Settings Page (3-Phase UPS)

[Parallel Setting Page](#)

This page allows the user to set the Parallel System Configuration mode parameters of the UPS. These functions are supported in the 3-phase UPS units only. This page is not available on the 5-10kVA single-phase UPS units. This page has the same two banners across the top of the page as described in the Status Menu page.

The main body of this page has the settings for the Parallel ID, the Number of Parallel Units, and the number of the Redundant Units. A Parallel System Configuration may be setup to have all units in parallel mode where total capacity of the system is the number of units in the system times the capacity of one unit. A Parallel System Configuration may alternately be setup in a parallel redundancy mode where total capacity of the system is the number of units in the system minus the number of redundant units in the system times the capacity of one unit.

Press the left/right arrow on the “Parallel ID” line to select a number from 1 to 6 for the parallel ID number of that UPS, default is 1. Each UPS in the Parallel Configuration System must have as unique ID number.

Press the left/right arrow on the “Parallel Basic Units” line to select the number of units (2 – 6) in the Parallel System Configuration, the default number is 2.

Press the left/right arrow on the (Parallel Redundancy Units” line to select the number of units (0 – 5) in the Parallel System that are redundant units, the default number is 0. When 0 is selected that means the Parallel System Configuration does not have redundancy. When 1 to 5 are selected that means the system has 1 to 5 redundant UPS units.

After making all the necessary changes on this page, press the “Save Config” button to save the changes.

Press the up and over arrow to return to the Advanced Setting Menu page.

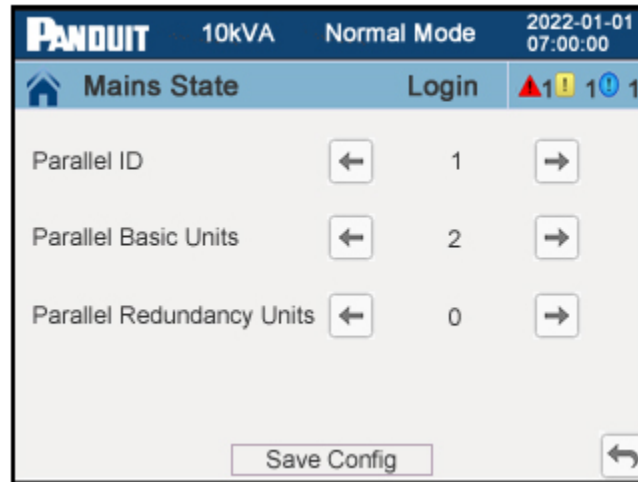

Figure 48: Parallel Setting Page

[Output Setting Page](#)

This page allows the user to set the output parameters on the UPS. This page has the same two banners across the top of the page as described in the Status Menu page.

The main body of this page has the settings for output frequency, output voltage, and output voltage adjustment.

Pressing the left/right arrows on the “Output Frequency (Hz)” line allows the user to select 50 or 60Hz as the desired output frequency of the UPS, default is depending on the UPS SKU. EU UPS units are defaulted to 50Hz, and NA UPS units are defaulted to 60Hz.

Pressing the left/right arrows on the “Output Voltage Level (V)” line allows the user to select the voltage value as the desired output voltage of the UPS, default is dependent on the UPS SKU. EU UPS units are defaulted to 230V, and NA UPS units are defaulted to 208V.

Pressing the left/right arrows on the “Inverter Volt Adjust (%)” line allows the user to select a -5% to +5% (in steps of 0.5%) adjustment to obtain the desired output voltage of the UPS, default is set to 0. This adjustment is critical in a Parallel mode system to

ensure the outputs of all UPS units in the system are the same. This enables optimal load sharing across the UPS units in the system. This adjustment is available only on the 3-Phase UPS units. Therefore, the single-phase 5-10kVA UPS units will not have the “Inverter Volt Adjust” line on this page.

After making all the necessary changes on this page, press the “Save Config” button to save the changes.

Press the up and over arrow to return to the Advanced Setting Menu page.

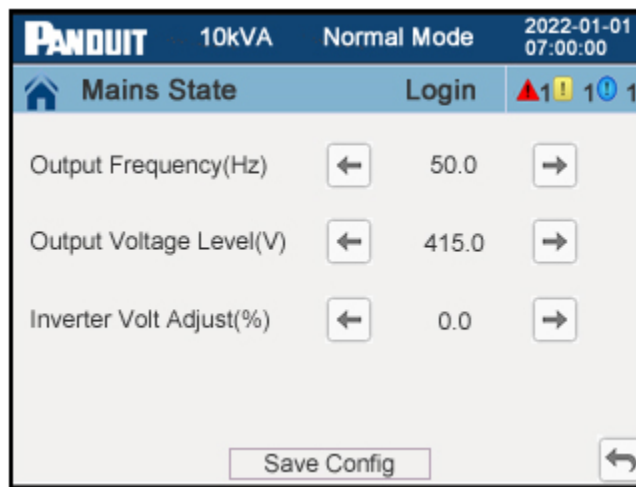

Figure 49: Output Setting Page

Battery Setting Pages

These two or three pages allow the user to set the system battery parameters of the UPS. Each page contain up to four parameters that may be changed, so the number of settable parameters in the UPS unit will dictate the number of Battery Setting pages in the system. These pages have the same two banners across the top of the page as described in the Status Menu page.

The main body of these pages have the general settings for the battery plant connected to the UPS. The parameters are listed in order that they will appear on these pages. If a parameter does not exist in a system that line will not appear in these pages.

Pressing the left/right arrows on the “Battery Group” line allows the user to select 1 to 8 for the number of EBP units connected the UPS, the default value is 1 EBP. NOTE: The 5-10kVA single-phase UPS units allow a maximum of five EBP units per UPS; the 10-20kVA 3-phase UPS allow a maximum of eight EBP units per UPS.

Pressing the left/right arrows on the “Boost Float Conversion” line allows the user to

select 0 to 24 for the number of months for the time to calculate the timing of changing from boost charge mode to float charge mode, the default value is 3 months. This is a battery life optimization tool. NOTE: This is supported only on the 3-Phase UPS units, so the single-phase UPS units will not have this line on these pages.

Pressing on the left/right arrows in the “Cell Float Volt (V/Cell)” line allows the user to adjust the battery cell float voltage from 2.20 to 2.29 V/cell, the default value is 2.25 V/cell. This is a battery life optimization parameter. NOTE: This is supported only on the 3-Phase UPS units, so the single-phase UPS units will not have this line present on these pages.

Pressing on the left/right arrows in the “Cell Boost Volt (V/Cell)” line allows the user to adjust the battery cell boost voltage from 2.30 to 2.40 V/cell, the default value is 2.30 V/cell. This is a battery life optimization parameter. Note: This is supported only on the 3-Phase UPS units, so the single-phase UPS units will not have this line present on these pages.

Pressing on the left/right arrows in the “Boost Charge Setting” line allows the user to enable or disable battery boost charging, the default is enabled. This is a battery life optimization parameter. Note: This is supported only on the 3-Phase UPS units, so the single-phase UPS units will not have this line present on these pages.

Pressing on the left/right arrows in the “No Battery Warning” line allows the user to enable or disable the warning when a battery is not present, the default is enabled. When enabled a warning will trigger on the system when a battery is not detected by the UPS unit.

Pressing on the left/right arrows in the “Shared Battery” line allows the user to enable or disable battery charging through the parallel UPS units in the system, the default is disabled. This allows the batteries to be charged from all the UPS units in the parallel system. Note: This feature is only supported in a parallel mode system and on the 3-Phase UPS units, so the single-phase UPS units will not have this line present on these pages.

Pressing on the left/right arrows in the “EOD G2 Battery Volt” line allows the user to select the cell voltage (1.75V, 1.84V or 1.92V) at which Outlet Group 2 will automatically turn OFF, the default is 1.75V, which is the same voltage that the system will turn OFF when running in battery mode. The higher cell voltage will turn OFF the outlet group sooner and allow longer runtime on the critical loads that are connected to Outlet Group 1. This is supported only on the single-phase 5-10kVA UPS units, so this line is not

present on the 3-Phase UPS units.

Pressing on the left/right arrows in the “EOD G3 Battery Volt” line allows the user to select the cell voltage (1.75V, 1.84V or 1.92V) at which Outlet Group 3 will automatically turn OFF, the default is 1.75V, which is the same voltage that the system will turn OFF when running in battery mode. The higher cell voltage will turn OFF the outlet group sooner and allow longer runtime on the critical loads that are connected to Outlet Group 1. This is supported only on the EU Single-Phase 6-10kVA UPS units (U06N12V, U06S12V, U10N12V and U06S12V), so this line is not present on the NA Single-Phase 5-10kVA or the 3-Phase UPS units.

On the “Installed Date” line, pressing on the number in front of the “Y” allows the user to type in the install year, pressing on the number in front of the “M” allows the user to type in the install month, and pressing on the number in front of the “D” allows the user to type in the install day. The default values for the year, month and day are based on when the battery was fully charged at build time. The user should change this date to the UPS install date at completion of installation.

On the “Replacement Notification” line, pressing on the number in front of the “Day” allows the user to type in the number of days from the install date that the UPS will alarm the user to replace the battery, the default is 730 days. The user should change this interval based on their company policies for replacing VLRA batteries.

After making all the necessary changes on each page, press the “Save Config” button before leaving the individual page to save the changes.

Press the down arrow to go to the next page. Press the up arrow to go to the previous page. Press the up and over arrow to return to the Advanced Setting Menu page.

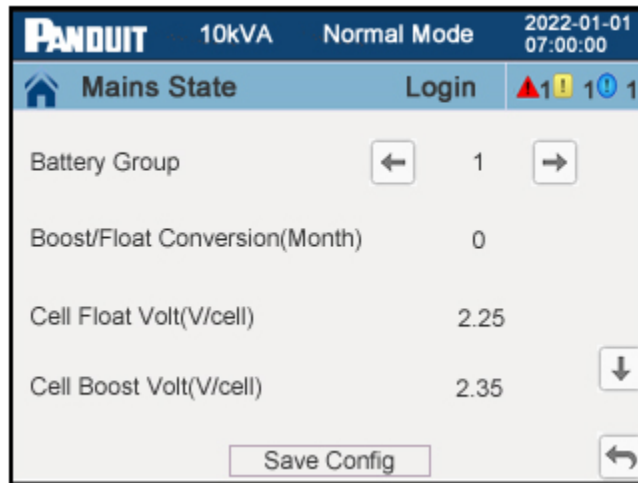

Figure 50: Battery Setting Page 1 (3-Phase UPS)

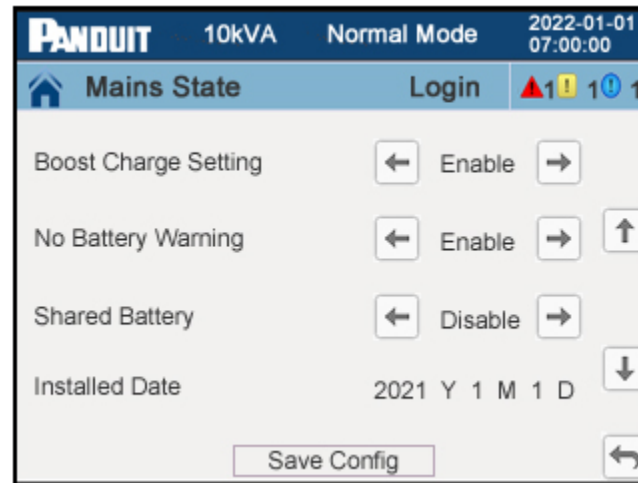

Figure 51: Battery Setting Page 2 (3-Phase UPS)

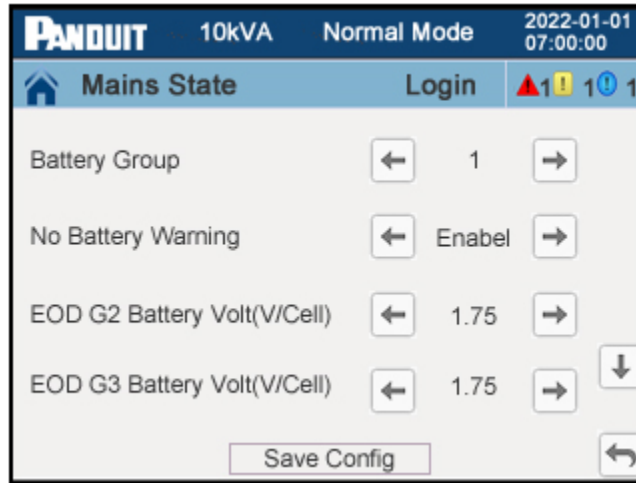

Figure 52: Battery Setting Page 1 (EU Single-Phase UPS)

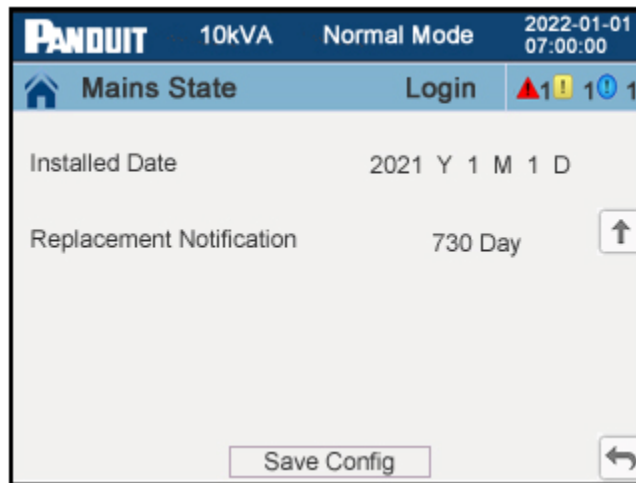

Figure 53: Battery Setting Page 2 (EU Single-Phase UPS)

[Bypass Setting Page](#)

This page allows the user to set the bypass limits and ranges on the UPS. This page has the same two banners across the top of the page as described in the Status Menu page.

The main body of this page has the settings for bypass voltage protection limits and frequency limits.

When the difference between the bypass voltage and the rated voltage exceeds the lower threshold for the bypass voltage, the system determines that the bypass voltage is abnormal and that the bypass is unavailable. Bypass unavailable means that if the UPS is operating Normal Mode, it cannot switch to bypass mode or if the UPS is

operating in ECO Mode it will switch to Battery Mode. This page allows the user to adjust this limit based on the tolerance of the loads connected to the output of the UPS. The “Bypass Volt Prot Lower Limit” line may be adjusted from -10% to -45% by using the left and right arrows to select the appropriate lower voltage limit, default is -15%.

When the difference between the bypass voltage and the rated voltage exceeds the upper threshold for the bypass voltage, the system determines that the bypass voltage is abnormal and that the bypass is unavailable. Bypass unavailable means that if the UPS is operating Normal Mode, it cannot switch to bypass mode or if the UPS is operating in ECO Mode it will switch to Battery Mode. This page allows the user to adjust this limit based on the tolerance of the loads connected to the output of the UPS. The “Bypass Volt Prot Upper Limit” line may be adjusted from 10% to 25% by using the left and right arrows to select the appropriate upper voltage limit, default is 10%.

When the difference between the bypass input frequency and the rated frequency is greater than the frequency tracking range, the system determines that the bypass frequency is not normal, and that the bypass is unavailable. Bypass unavailable means that if the UPS is operating Normal Mode, it cannot switch to bypass mode or if the UPS is operating in ECO Mode it will switch to Battery Mode. This page allows the user to adjust this limit based on the tolerance of the loads connected to the output of the UPS. The “Bypass Freq Tracking Range” line may be adjusted from $\pm 1\%$ to $\pm 10\%$ by using the left and right arrows to select the appropriate frequency tracking range, default is $\pm 10\%$.

After making all the necessary changes on this page, press the “Save Config” button to save the changes.

Press the up and over arrow to go to the Advanced Setting Menu page.

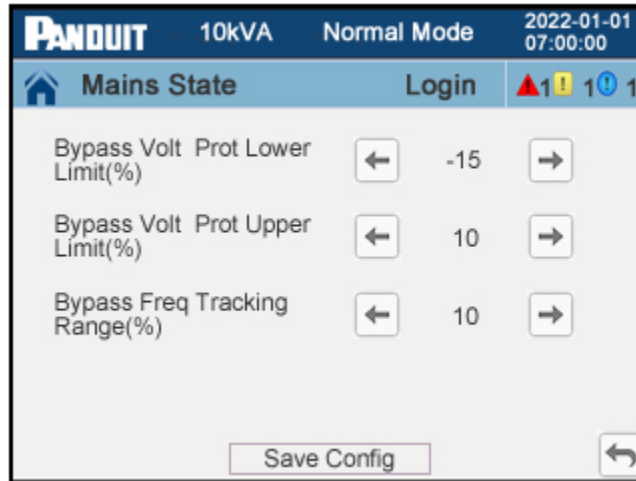

Figure 54: Bypass Setting Page

Dry Contact Setting Pages

These two pages allow the user to set the meaning of the internal input and output dry contact ports on the 3-phase UPS units only. These pages will not be available on the 5-10kVA Single-Phase UPS units. These pages have the same two banners across the top of the page as described in the Status Menu page.

Input Dry Contact Setting Page

The main body of this page contains the settings for the four input dry contact ports internal in the UPS.

Pressing the left/right arrows on the “IN 01” line allows the user to select the meaning (close, INV ON, INV OFF, BATT Fault, Generator, User Alarm3, User Alarm4, Forbidden ECO, Force INV OFF, Input Switch, Bypass Switch, BATT Switch, BATT Trip, BATT Ground, Thunder, or EPO) of the first input dry contact (between IN pins 1 and 2), default is Close. Close means there is nothing assigned to this input dry contact. If “INV ON” is assigned to this contact, then a remote closure of this contact will cause the inverter to turn ON.

Pressing the left/right arrows on the “IN 02” line allows the user to select the meaning of the second input dry contact (between IN pins 3 and 4), default is Close. Close means there is nothing assigned to this input dry contact. If “INV OFF” is assigned to this contact, then a remote closure of this contact will cause the inverter to turn OFF.

Pressing the left/right arrows on the “IN 03” line allows the user to select the meaning of the third input dry contact (between IN pins 5 and 6), default is Close. Close means there is nothing assigned to this input dry contact.

Pressing the left/right arrows on the “IN 04” line allows the user to select the meaning of the fourth input dry contact (between IN pins 7 and 8), default is Close. Close means there is nothing assigned to this input dry contact.

After making all the necessary changes on this page, press the “Save Config” button to save the changes.

Press the down arrow to go to the next page. Press the up and over arrow to return to the Advanced Setting Menu page.

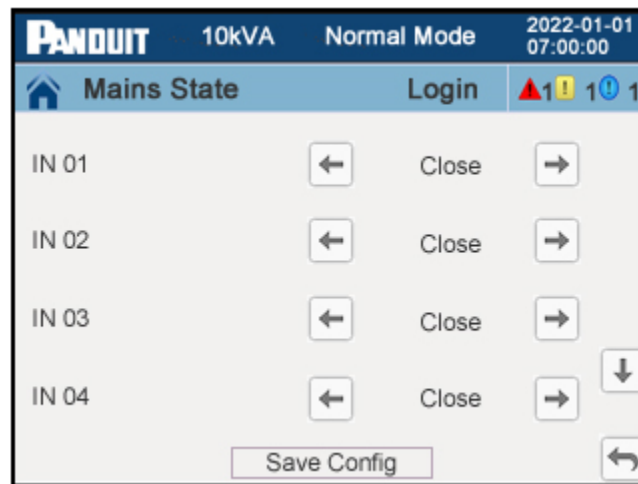

Figure 55: Input Dry Contact Setting Page – 3-Phase UPS Only

Output Dry Contact Setting Page

The main body of this page contains the settings for the four output dry contacts internal in the UPS.

Pressing on the button field next to the “OUT 1” contact toggles the sense of this output contact between “Normally Opened” and “Normally Closed”. Pressing the left/right arrows on the “OUT 01” line allows the user to select the meaning (close, UPS Warning, Online Mode, Battery Mode, Bypass Mode, INV Overload, Fan Fault, Battery Fault, Battery Disconnected, Battery Low Voltage, Mains Abnormal, Bypass Not Available, EPO, Maintenance Bypass Mode, Parallel Communications Fault, or ECO Mode) of the first output dry contact (between OUT pins 1 and 2), default is Close.

Pressing on the button field next to the “OUT 2” contact toggles the sense of this output contact between “Normally Opened” and “Normally Closed”. Pressing the left/right arrows on the “OUT 02” line allows the user to select the meaning of the second output dry contact (between OUT pins 3 and 4), default is Close.

Pressing on the button field next to the “OUT 3” contact toggles the sense of this output contact between “Normally Opened” and “Normally Closed”. Pressing the left/right arrows on the “OUT 03” line allows the user to select the meaning of the third output dry contact (between OUT pins 5 and 6), default is Close.

Pressing on the button field next to the “OUT 4” contact toggles the sense of this output contact between “Normally Opened” and “Normally Closed”. Pressing the left/right arrows on the “OUT 04” line allows the user to select the meaning of the fourth output dry contact (between OUT pins 7 and 8), default is Close.

After making all the necessary changes on this page, press the “Save Config” button to save the changes.

Press on the up arrow to go to the previous page. Press the down arrow to go to the next page. Press the up and over arrow to return to the Advanced Setting Menu page.

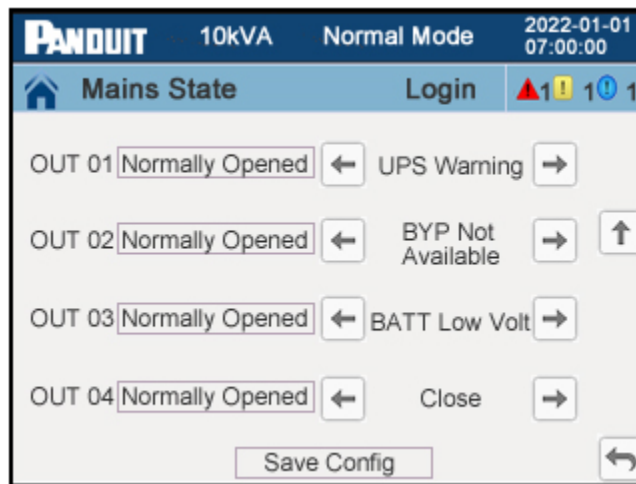

Figure 56: Output Dry Contact Setting Page – 3-Phase UPS Only

Maintenance Pages

The maintenance pages have several pages, the first page provides a menu of the two maintenance pages. Maintenance pages are used to perform maintenance/testing on the UPS.

Maintenance Menu Page

This is the menu page for the UPS maintenance pages. This page has the same two banners across the top of the page and the same banner along the bottom of the page as described in the Status Menu page.

The main body of this page has two levels that may be pressed to transition the FPD to

the Battery Self-Check page or the Touch Screen Correction page.

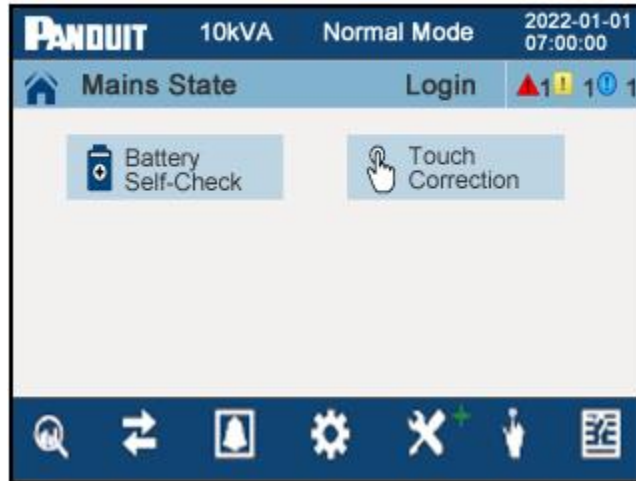

Figure 57: Maintenance Menu Page

[Battery Self-Check Page](#)

This page has the same two banners across the top of the page and the same banner along the bottom of the page as described in the Status Menu page.

The main body of this page contains the settings for the Automatic Self-Check and the menu page to each of the Automatic Self-Check setup pages. The top spot in the list contains the current setting of the Automatic Self-Check mode. The user may press on any one of the desired self-check modes in the list which will automatically transition the FPD to that setup page, default Automatic Self-Check mode is disabled. Disable means that no self-checking is scheduled to be performed.

Pressing “Disable” transitions the FPD to the “Disable” Settings page.

Pressing “Monthly” transitions the FPD to the “Monthly” Settings page.

Pressing the “Weekly” transitions the FPD to the “Weekly” Settings page.

Pressing the “Interval” transitions the FPD to the “Interval” Settings page.

Press the up and over arrow to return to the Maintenance Menu page.

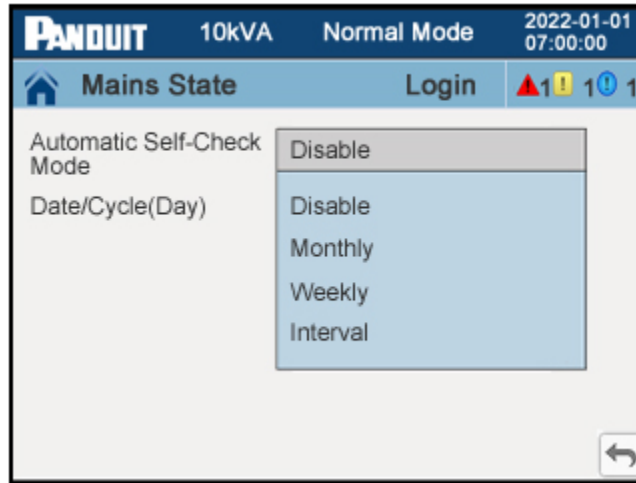

Figure 58: Input Dry Contact Setting Page

[Auto Self-Check Disable Setting Page](#)

This page has the same two banners across the top of the page and the same banner along the bottom of the page as described in the Status Menu page.

The main body of this page shows the setting for the disable of the automatic self-check of the UPS. There are no options on this page, this page is just used to disable the Auto Self-Check.

Press the “Save Config” button to disable the Automatic Self-Check.

Press the up and over arrow to return to the Battery Self-Check page. NOTE: Upon returning to this page, the “Self-Check Mode” line will have “Disable” in the field on the top of the list. The self-check battery test is now disabled.

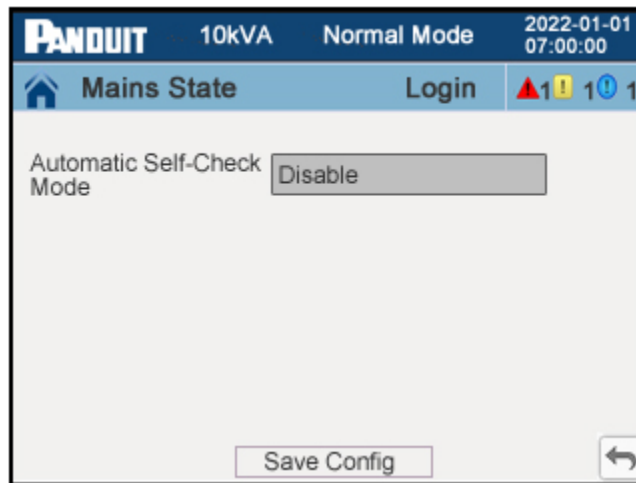

Figure 59: Auto Self-Check Disable Setting Page

[Auto Self-Check Monthly Setting Page](#)

This page has the same two banners across the top of the page and the same banner along the bottom of the page as described in the Status Menu page.

The main body of this page contains the settings for the monthly automatic self-check of the UPS.

Pressing on the number in front of the Day allows the user to select the day in the month that the self-check battery test should be run.

Pressing on the number in front of the Hour allows the user to select the hour in that day that the self-check battery test should be run. NOTE: This field is based on a 24-hour clock.

Pressing on the number in front of the Min allows the user to select the minute in that hour that the self-check battery test should start.

After making all the necessary changes on this page, press the “Save Config” button to save the changes.

Press the up and over arrow to return to the Battery Self-Check page. NOTE: Upon returning to this page, the “Self-Check Mode” line will have “Monthly” in the field on the top of the list. The self-check battery test is now scheduled to automatically run once a month on the day specified, at the hour specified and start at the minute specified.

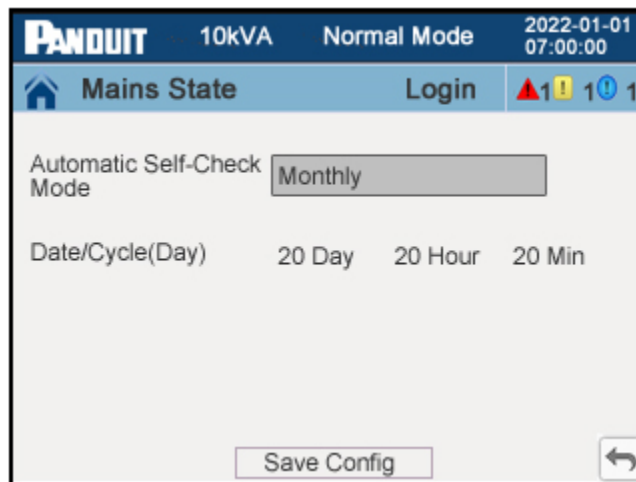

Figure 60: Auto Self-Check Monthly Setting Page

[Auto Self-Check Weekly Setting Page](#)

This page has the same two banners across the top of the page and the same banner along the bottom of the page as described in the Status Menu page.

The main body of this page contains the settings for the weekly automatic self-check of the UPS.

Pressing on the left/right arrows on the “Date/Cycle(day)” allows the user to select the day in a week (Sunday – Saturday) that the self-check test should be run.

Pressing on the number in front of the Hour allows the user to select the hour in that day that the self-check test should be run. NOTE: This field is based on a 24-hour clock.

Pressing on the number in front of the Min allows the user to select the minute in that hour that the self-check test should start.

After making all the necessary changes on this page, press the “Save Config” button to save the changes.

Press the up and over arrow to return to the Battery Self-Check page. NOTE: Upon returning to this page, the “Self-Check Mode” line will have “Weekly” in the field at the top of the list. The self-check battery test is now scheduled to automatically run once a week on the day specified, at the hour specified and start at the minute specified.

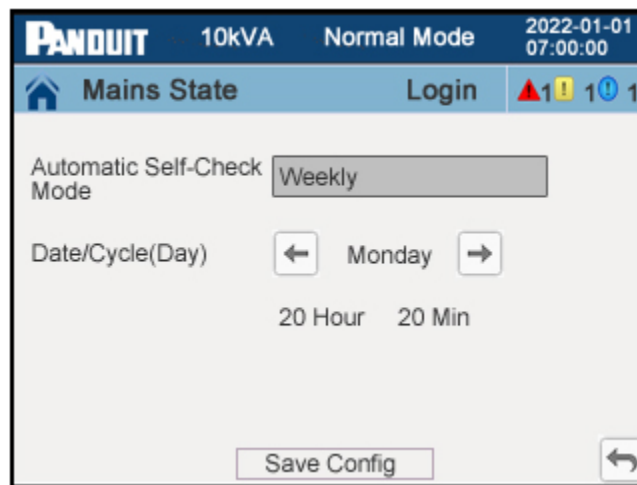

Figure 61: Auto Self-Check Weekly Setting Page

[Auto Self-Check Interval Setting Page](#)

This page has the same two banners across the top of the page and the same banner along the bottom of the page as described in the Status Menu page.

The main body of this page contains the settings for the interval (in days) that the automatic self-check of the UPS should run.

Pressing on the number before the days in the “Day/Cycle (Day)” line allows the user to

select the number of days between each automatic self-check test, default is 30 days.

After making all the necessary changes on this page, press the “Save Config” button to save the changes.

Press the up and over arrow to return to the Battery Self-Check page. NOTE: Upon returning to this page, the “Self-Check Mode” line will have “Interval” in the field at the top of the list. The self-check battery test is now scheduled to automatically run once every number of days as specified on this page.

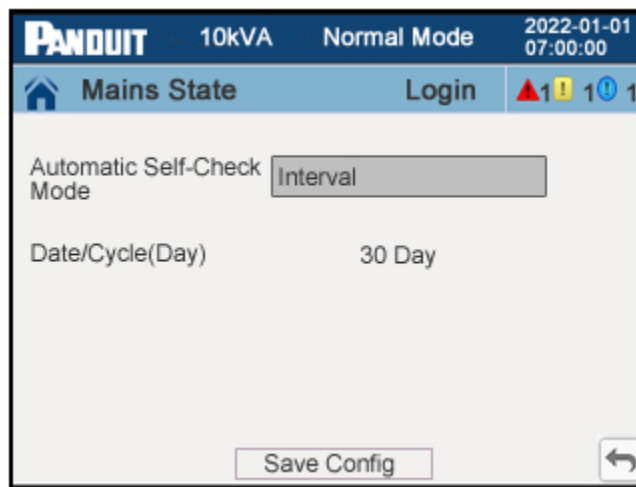

Figure 62: Auto Self-Check Interval Setting Page

[Touch Correction Page](#)

The touch correction page shows an x-y cross hair on the screen. The user must touch the intersection of the cross hair for the first screen calibration. Another x-y cross hair appears in another location on the screen, the user must touch the intersection of the cross hair to complete the screen calibration. Upon completion of the calibration the FPD automatically transitions back to the Maintenance Menu Page.

Common Pages

The common pages have several pages, the first page provides a menu of the three or four common pages. Common pages are used to perform manual operations on the UPS.

[Common Menu Page](#)

This is the menu page for the UPS common pages. This page has the same two banners across the top of the page and the same banner along the bottom of the page as described in the Status Menu page.

The main body of this page has three or four levels that may be pressed to transition the FPD to the Outlet Group Control page (for Single-Phase UPS units only, all outputs on the 3-phase units are hardwired), Inverter ON/OFF page, the Battery Test page, or the Alarm Clear page.

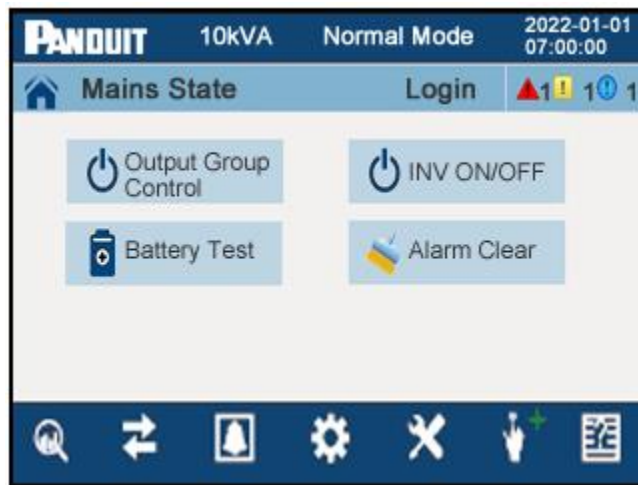

Figure 63: Common Menu Page (Single Phase UPS)

[Outlet Group Control Page](#)

This page has the same two banners across the top of the page as described in the Status Menu page.

The main body of this page allows the user to turn ON and OFF each controllable outlet group. The EU Single-Phase UPS units have two controllable outlet groups (Outlet Group 2 and outlet Group 3). The NA Single-Phase UPS units have only one controllable outlet group (Outlet Group 2), the page will only have Group 2 for these units. Once the OFF or ON location is pressed on an outlet group the action will take effect immediately.

Press the up and over arrow to return to the Common Menu page.

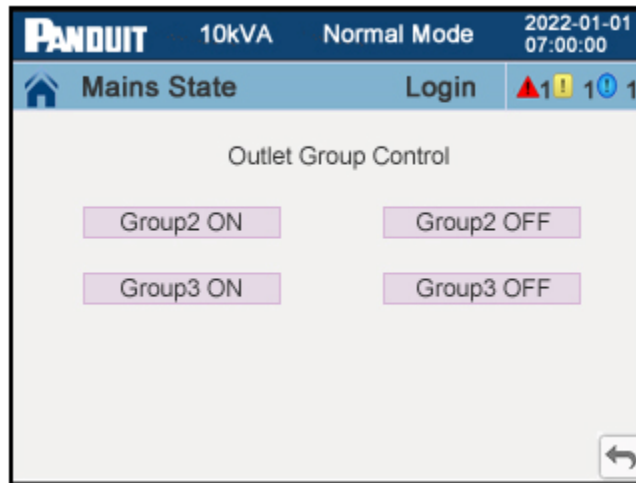

Figure 64: Outlet Group Control Page (Single-Phase EU UPS)

[Inverter ON/OFF Page](#)

This page has the same two banners across the top of the page as described in the Status Menu page.

The main body of this page allows the user to turn ON and OFF the system output inverter(s). If the system configuration is Single Mode (a system configured with only one UPS), then the user may press the “Single ON” or “Single OFF” button to turn ON or turn OFF the UPS output inverter. If the system configuration is Parallel Mode (a system configured with 2 or more UPS unit connected in parallel), then the user should press the “Parallel ON” or “Parallel OFF” button to turn ON or OFF the group of parallel UPS output inverters. The 5-10kVA Single Phase UPS units will only have a single ON and a single OFF location, since single-phase UPS units cannot be used in a parallel configuration mode. When the inverter(s) is turned OFF, system will then transition to Bypass Mode, assuming bypass mode has not been previously disabled. If Bypass Mode has been previously disabled, then the system output will shut down. Once the Inverter OFF or ON location is pressed the action will take effect immediately.

Press the up and over arrow to return to the Common Menu page.

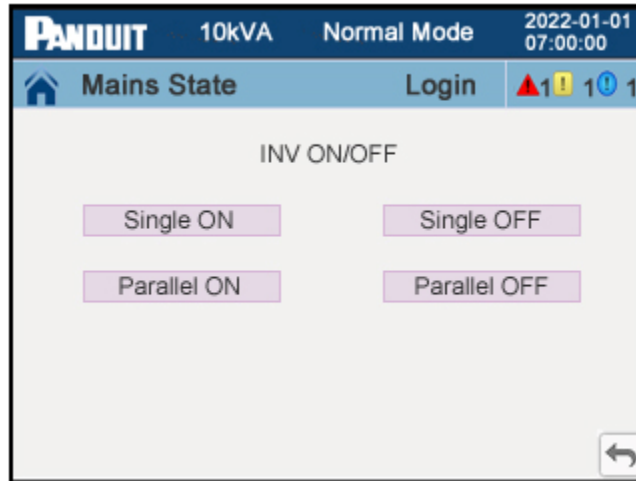

Figure 65: Inverter ON/OFF Page (3-Phase UPS)

[Battery Manual Test Page](#)

This page has the same two banners across the top of the page as described in the Status Menu page.

The main body of this page contains the locations to Start or Stop the manual one-time Battery Test. Pressing the “Start Manual Self-Check” location will immediately starts the battery test. Pressing the “Stop Manual Self-Check” location will immediately stops the battery test.

Press the up and over arrow to return to the Common Menu page.

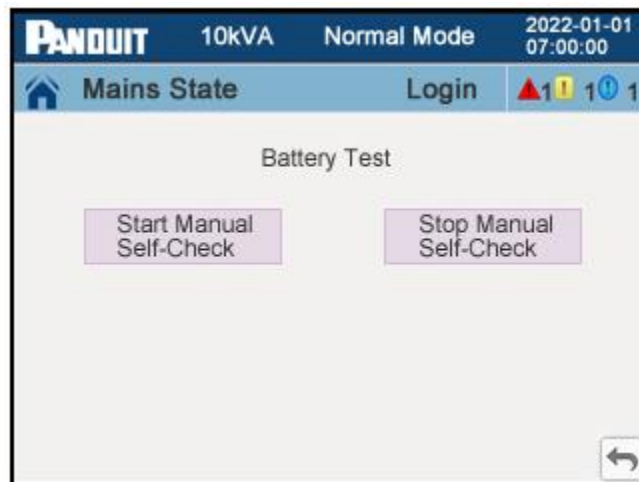

Figure 66: Battery Manual Test Page

[Alarm Clear Page](#)

This page has the same two banners across the top of the page as described in the Status Menu page.

The main body of this page contains a confirmation popup to clear all the user settable alarms on the system.

Pressing on “Confirm” clears all the user settable alarms on the system. Pressing on the cancel returns the FPD back to the Common Menu page.

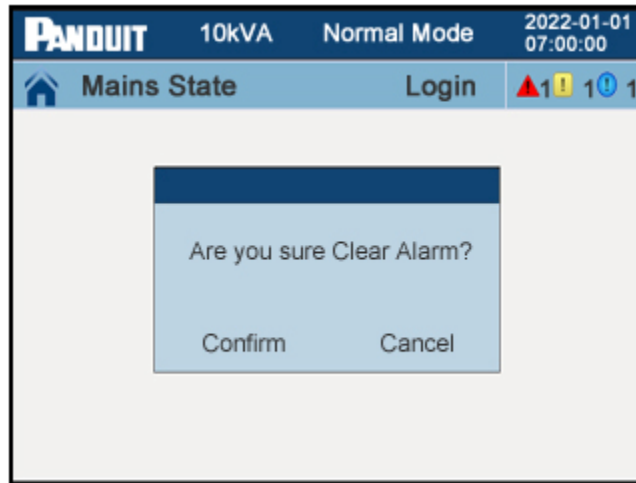

Figure 67: Alarm Clear Page

About Pages

The About pages are used to provide high-level information about the UPS and the firmware loaded in the core modules of the UPS. The first page provides general information about the UPS and maps to the FW information that is currently on each processor in the UPS.

About Menu Page

This page has the same two banners across the top of the page and the same banner along the bottom of the page as described in the Status Menu page.

The main body of this page has the UPS SKU (Part) Number, the UPS Serial Number, the Manufacture Date, and a link to the UPS Firmware Version pages.

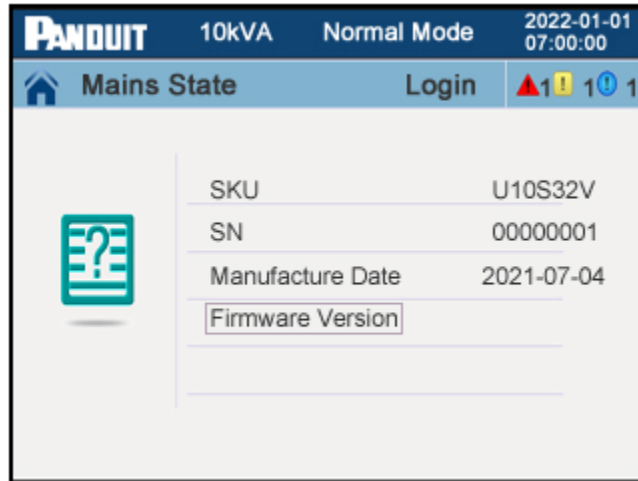

Figure 68: About Menu Page (3-Phase 10kVA UPS)

UPS Firmware Version Pages

These pages have the same two banners across the top of the page as described in the Status Menu page.

The main body of this page contains the firmware versions of the modules in the UPS. Each page contains five modules. The 3-phase UPS has the LCD Firmware Version, the Monitor Firmware Version, the UPS Rectifier CPLD Firmware Version, UPS Rectifier DSP Firmware Version, the UPS Inverter CPLD Firmware Version, and the UPS Inverter DSP Firmware version, so the firmware versions span across two UPS Firmware Version pages.

Press on the down arrow to go to the next UPS Firmware Version page. Press on the up and over arrow to go to the About Menu page.

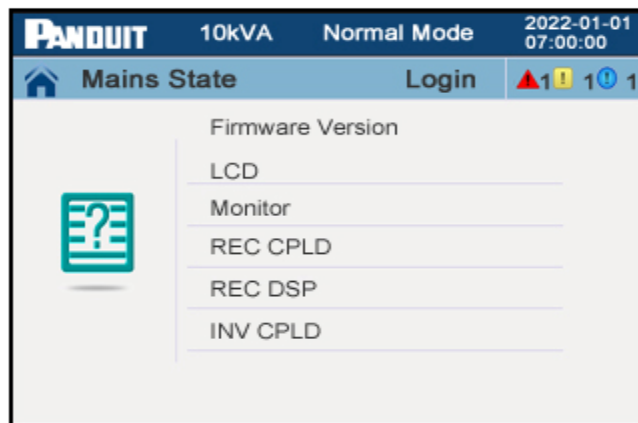

Figure 69: UPS Firmware Version Page 1 (3-Phase UPS)

Press on the up arrow to go to the previous UPS Firmware Version page. Press on the up and over arrow to go to the About Menu page.

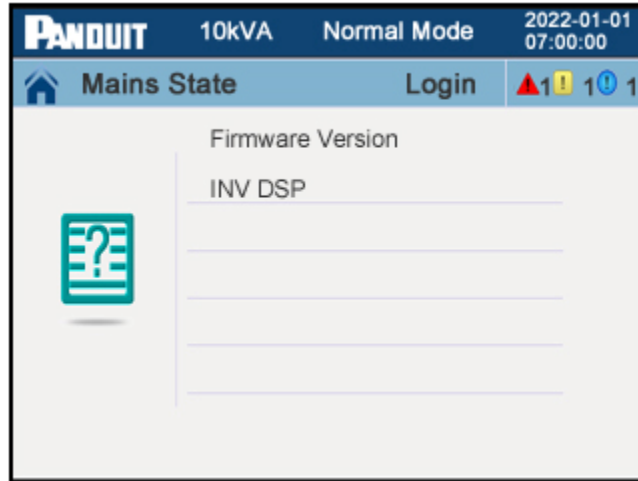

Figure 70: UPS Firmware Version Page 2 (3-Phase UPS)

The single-phase 5-10kVA UPS has the LCD Firmware Version, the Monitor Firmware Version, the UPS CPLD Firmware Version, UPS DSP Firmware version, so the firmware version span across one UPS Firmware Version page.

Press on the up and over arrow to go to the About Menu page.

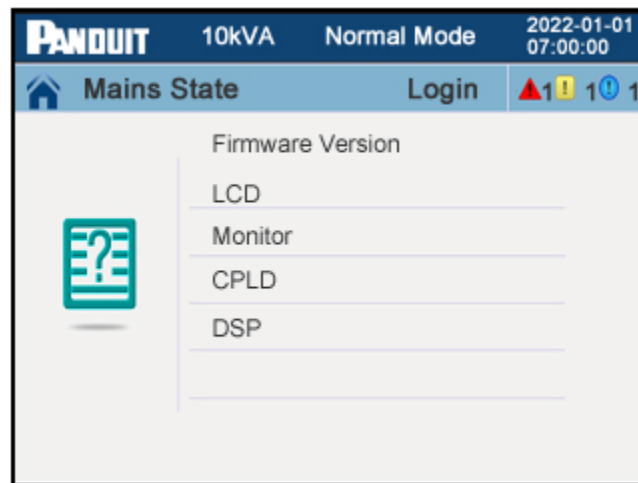

Figure 71: UPS Firmware Version Page (Single Phase UPS)

Appendix A1: 5 to 10kVA Fault/Alarm Codes

The following Error Code Tables list the available Fault and Alarm codes shown on the display of the 5 to 10kVA 1-Phase UPS Family.

The Buzzer will make a continuous beep or periodic beep (about 1 per second).

The Alarm/Fault LED will either illuminate Yellow for Alarm or Red for Fault. Additional LEDs that will illuminate are Yellow Battery LED, and the Blue Inverter LED.

Error Code	Error Description	Error Type	Buzzer	LED
1	Input Phase Sequence Error	Fault	Periodic	Fault On
2	Input Voltage High	Alarm	Periodic	None
3	Input Voltage Low	Alarm	Periodic	None
4	Input Frequency Abnormal	Alarm	Periodic	None
5	+DC bus Over Voltage	Alarm	Continuous	Alert On
6	-DC bus Over Voltage	Alarm	Continuous	Alert On
7	DC bus OV Hardware circuit	Fault	Continuous	Fault On
8	+DC bus Low Voltage (output on)	Alarm	Continuous	Alert On
9	-DC bus Low Voltage (output on)	Alarm	Continuous	Alert On
10	+DC Bus Voltage Low (output off)	Alarm	Continuous	Alert On
11	-DC Bus Voltage Low (output off)	Alarm	Continuous	Alert On
12	DC bus Delta(line)	Alarm	Continuous	Alert On
13	DC bus Delta (on battery)	Alarm	Continuous	Alert On
14	+DC Bus soft start Fail (Line)	Fault	Continuous	Fault On
15	-DC Bus soft start Fail (Line)	Fault	Continuous	Fault On
16	+DC Bus soft start Fail (Battery)	Fault	Continuous	Fault On
17	-DC Bus soft start Fail (Battery)	Fault	Continuous	Fault On
18	+DC Bus Discharge Fail	Fault	Continuous	Fault On
19	-DC Bus Discharge Fail	Fault	Continuous	Fault On
21	Inverter Output Low	Fault	Continuous	Fault On
22	Inverter Output High	Fault	Continuous	Fault On
23	Inverter hardware CKT	Fault	Continuous	Fault On
24	Output Relay Weld Close	Fault	Continuous	Fault On
25	Output Relay Weld Open	Fault	Continuous	Fault On

Error Code	Error Description	Error Type	Buzzer	LED
26	Inverter Overload	Alarm	Periodic	Bypass Blink
27	Inverter Overload Time Out	Alarm	Periodic	Bypass Blink
28	Inverter DC Over Voltage	Alarm	Periodic	Bypass Blink
29	Output Measurement Mismatch	Fault	Continuous	Fault On
30	Inverter soft start Fail	Fault	Continuous	Fault On
32	Output Short Circuit	Fault	Continuous	Fault On
33	Output Over Voltage	Fault	Continuous	Fault On
34	Output Severe Over Voltage	Fault	Continuous	Fault On
35	Output Low Voltage	Fault	Continuous	Fault On
36	Output Over VA	Alarm	Periodic	None
38	Battery Reverse Connection	Fault	Periodic	Fault On
39	+Battery Over Voltage	Alarm	Periodic	Battery Blink
40	-Battery Over Voltage	Alarm	Periodic	Battery Blink
41	+Battery Disconnected	Alarm	Periodic	Battery Blink
42	-Battery Disconnected	Alarm	Periodic	Battery Blink
43	+Battery Low Pre-Alarm	Alarm	Periodic	Battery Blink
44	-Battery Low Pre-Alarm	Alarm	Periodic	Battery Blink
45	+Battery Low Voltage	Alarm	Periodic	Battery Blink
46	-Battery Low Voltage	Alarm	Periodic	Battery Blink
47	RBC Needs Replacement	Fault	Periodic	Fault On
48	+Charger Error	Fault	Continuous	Fault On
49	-Charger Error	Fault	Continuous	Fault On
50	+Charger Over Voltage	Alarm	Periodic	Yellow
51	-Charger Over Voltage	Alarm	Periodic	Alert On
52	+Charger Low Voltage	Alarm	none	Alert On
53	-Charger Low Voltage	Alarm	none	Alert On
54	Charger Measurement Mismatch	Fault	Periodic	Fault On
56	Bypass Phase Sequence Error	Fault	Periodic	None
57	Bypass Over Current	Alarm	Periodic	Bypass Blink
58	Bypass Voltage Abnormal	Alarm	none	Bypass Blink
59	Bypass Frequency Abnormal	Alarm	none	Bypass Blink
60	Bypass Overload	Alarm	Periodic	Bypass Blink

Error Code	Error Description	Error Type	Buzzer	LED
61	Bypass Overload Time Out	Alarm	Periodic	None
62	PDU ACTIVATED	Alarm	none	None
64	Battery Over Temp Critical	Alarm	Continuous	Alert On
65	Battery Low Temperature	Alarm	Continuous	Alert On
66	battery Over Temp	Alarm	Continuous	Alert On
67	Battery Temp Sensor Disconnected	Alarm	Continuous	Alert On
68	Fan Inoperative	Fault	Continuous	Fault On
69	Heatsink over temp	Alarm	Continuous	Alert On
70	Heatsink over temp	Alarm	Continuous	Alert On
71	Ambient Over Temperature	Alarm	Periodic	Alert On
72	Ambient Low Temperature	Alarm	Periodic	Alert On
74	Bypass Rly weld close	Fault	Continuous	Fault On
75	Bypass Rly weld Open	Fault	Continuous	Fault On
76	Back feed Relay Weld close	Fault	Continuous	Fault On
77	Back feed Relay Weld Open	Fault	Continuous	Fault On
78	Logic Power Supply Event	Alarm	Continuous	Alert On
79	EEPROM Error	Fault	Continuous	Fault On
80	RAM Error	Fault	Continuous	Fault On
81	Para Communication Error	Alarm	Continuous	Alert On
82	Internal Communications Fault	Alarm	Continuous	Alert On
83	CPLD Fault	Alarm	Continuous	Alert On
84	MCU Reset	Fault	Continuous	Fault On
85	Back feed Relay locked	Alarm	Periodic	Alert On
86	BMS Communication Error	Alarm	Periodic	Alert On
88	Para Relay Error	Fault	Continuous	Fault On
89	Para Connect Error	Alarm	Continuous	Alert On
90	Para Current Share Error	Alarm	Periodic	Alert On
91	Para Overload	Alarm	Periodic	none
93	Button error	Fault	Periodic	Fault On
95	EPO ACTIVATED	Fault	Continuous	Fault On
96	Firmware Mismatch	Fault	Continuous	Fault On
99	Firmware Upgrading	Alarm	Periodic	Alert On

Appendix A2: 10 to 20kVA Fault/Alarm Codes

The following Error Code Tables list the available Fault and Alarm codes shown on the display of the 10 to 20kVA 3-Phase UPS Family.

The Buzzer will make a continuous beep or periodic beep (about 1 per second).

The Alarm/Fault LED will either illuminate Yellow for Alarm or Red for Fault. Additional LEDs that will illuminate are Yellow Battery LED, and the Blue Inverter LED.

Error Code	Error Description	Error Type	Buzzer	LED
002	REC Over Temperature	Fault	Periodic	Fault On
003	REC par. cable Fault	Fault	Periodic	Fault On
004	REC Over Current	Fault	Periodic	Fault On
005	REC Power Fault	Fault	Periodic	Fault On
007	Input SCR Fault	Fault	Periodic	Fault On
00A	Battery SCR Fault	Fault	Periodic	Fault On
00C	Charge SCR Fault	Fault	Periodic	Fault On
00E	Fan Fault	Fault	Periodic	Fault On
011	Fan Power fault	Fault	Periodic	Fault On
012	Charger Over Temp.	Fault	Continuous	Fault On
013	Soft Start Failed	Fault	Continuous	Fault On
014	BAT Charger Fault	Fault	Continuous	Fault On
016	REC Comm. Fault	Fault	Periodic	Fault On
019	REC Initializes Fault	Fault	Continuous	Fault On
01D	Unit insert fault	Fault	Periodic	Fault On
01E	Rectifier Fault	Fault	Continuous	Fault On
041	Inverter Fault	Fault	Continuous	Fault On
044	INV IGBT SHORT	Fault	Continuous	Fault On
047	Inverter relay Short	Fault	Continuous	Fault On
04A	Inverter relay Broken	Fault	Continuous	Fault On
04D	INV par. cable Fault	Fault	Periodic	Fault On
051	Output Short Circuit	Fault	Periodic	Fault On
054	INV Comm. Fault	Fault	Periodic	Fault On
057	INV Initializes Fault	Fault	Continuous	Fault On

Error Code	Error Description	Error Type	Buzzer	LED
05A	INV self-test Fault	Fault	Continuous	Fault On
05E	DC Component Fault	Fault	Periodic	Fault On
061	DC bus abnormal	Fault	Continuous	Fault On
063	Unit insert fault	Fault	Periodic	Fault On
064	INV DSP Power Fault	Fault	Continuous	Fault On
067	INV Over Temperature	Fault	Periodic	Fault On
068	Load Sharing Fault	Fault	Periodic	Fault On
06A	Cabinet mode Fault	Fault	Continuous	Fault On
06B	Fuse Broken	Fault	Continuous	Fault On
081	Par. cable Fault	Fault	Periodic	Fault On
086	ECU Insert Fault	Fault	Periodic	Fault On
088	ECU Power Fault	Fault	Continuous	Fault On
08B	ECU Comm. Fault	Fault	Continuous	Fault On
08D	ECU Initializes Fault	Fault	Periodic	Fault On
091	Bypass SCR Broken	Fault	Continuous	Fault On
094	Bypass SCR short	Fault	Continuous	Fault On
097	BPS Over Temperature	Fault	Continuous	Fault On
09A	Output CT Reverse	Fault	Continuous	Fault On
09D	Bypass Feedback Fault	Fault	Continuous	Fault On
0C2	Bypass SCR Broken	Fault	Continuous	Fault On
0C5	Bypass SCR short	Fault	Continuous	Fault On
0CF	BPS Over Temperature	Fault	Continuous	Fault On
103	Battery Over Voltage	Alarm	Periodic	Battery Blink
104	BAT Low Pre-warning	Alarm	Periodic	Battery Blink
105	Battery Reverse	Alarm	Periodic	Battery Blink
106	Battery EOD	Alarm	Periodic	Battery Blink
107	Battery Voltage low	Alarm	Periodic	Battery Blink
108	No Battery	Alarm	Periodic	Battery Blink
109	Input Phase Reverse	Alarm	Periodic	Bypass Blink
10A	Input N-Line lost	Alarm	Periodic	Bypass Blink
10B	Mains Freq. Abnormal	Alarm	Periodic	Bypass Blink
10C	Mains Volt. Abnormal	Alarm	Periodic	Bypass Blink

Error Code	Error Description	Error Type	Buzzer	LED
10D	REC Comm. Error	Alarm	Periodic	Bypass Blink
10E	Mains input lost	Alarm	Periodic	None
10F	Set Data Err.	Alarm	Periodic	Alarm On
121	INV Par. cable abnormal	Alarm	Periodic	Alarm On
125	INV Overload	Alarm	Periodic	Bypass Blink
126	INV not synchronized	Alarm	Continuous	Bypass Blink
12A	INV Set Data Err	Alarm	Periodic	Alarm On
129	INV Comm. Error	Alarm	Periodic	Alarm On
141	Bypass Switch to Num	Alarm	Periodic	Bypass Blink
142	Unit quantity mismatch	Alarm	Periodic	Bypass Blink
143	Parallel Overload	Alarm	Periodic	Bypass Blink
144	Bypass Overload	Alarm	Periodic	Bypass Blink
145	Maintenance Switch Misuse	Alarm	Periodic	Alarm On
146	ECU Comm. Error	Alarm	Periodic	Alarm On
147	Par. cable abnormal	Alarm	Periodic	Alarm On
14B	ECU Par. cable abnormal	Alarm	Periodic	Alarm On
14C	ECU Abnormal	Alarm	Periodic	Alarm On
14E	BPS Phase Reversed	Alarm	Periodic	Bypass Blink
14F	BPS Unable To Trace	Alarm	Periodic	Bypass Blink
150	BPS Not Available	Alarm	Periodic	Bypass Blink
151	Ecu Set Data Err	Alarm	Periodic	Alarm On
162	BPS Phase Reversed	Alarm	Periodic	Bypass Blink
163	BPS Unable To Trace	Alarm	Periodic	Bypass Blink
164	BPS Not Available	Alarm	Periodic	Bypass Blink

Appendix B: Troubleshooting

In case the UPS cannot work normally, it might be wrong in installation, wiring or operation. Please check these aspects first. If all these aspects are checked without any problem, please consult with local agent right away and provide below information.

- Product model name and serial number.
- Try to describe the fault with more details, such as LCD display info, LED lights status, etc.

Read the user manual carefully, it can help a lot for using this UPS in the right way. Some FAQ (frequently asked questions) may help you to troubleshoot your problem easily.

No.	Problem	Possible reason	Solution
1	Utility is connected but the UPS cannot be powered ON.	Input power supply is not connected; Input voltage low; The input switch of the UPS is not switched on.	Measure if the UPS input voltage/frequency is within the window. Check if UPS input is switched on
2	Utility normal but Utility LED does not light on, and the UPS operates at battery mode	The input breakers of the UPS are not switched on; input cable is not well connected	Switch on the input breaker; Make sure the input cable is well connected.
3	The UPS does not indicate any failure, but output do not have voltage	Output cable does not well connected; Output breaker do not switch on	Make sure the output cable is well connected; Switch on the output breaker.
4	Utility LED is flashing	Utility voltage exceeds UPS input range.	If the UPS operates at battery mode, please pay attention to the remaining backup time needed for your system.
5	Battery LED is flashing but	Battery breaker does not switch on, or batteries	Switch on the battery breaker. If batteries are damaged, need to

	no charge voltage and current	are damaged, or battery is reversely connected. Battery number and capacity are not set correctly.	replace whole group batteries, Connect the battery cables correctly; Go to LCD setting of the battery number and capacity, set the correct data.
6	Buzzer beeps every 0.5 seconds and LCD display “output overload”	Overload	Remove some load
7	The UPS only works on bypass mode	The UPS is set to ECO mode, or the transfer times to bypass mode are limited.	Set the UPS working mode to UPS type(non-parallel) or to reset the times of transferring to bypass or re-start the UPS
8	Cannot Black start	Battery switch is not properly closed: Battery fuse is not open: Or Battery low: Battery quantity set wrong; Power breaker in the rear panel not switch ON.	Close the battery switch: Change the fuse: Recharge the battery: Power ON the UPS with AC to set the battery quantity & quantity; Switch on the power breaker.

Appendix C: Configuration Options

The following options should be configured on a newly installed UPS System. These are the minimum options that should be configured after initial power up of the system. Other options could be configured later. However, if the system being powered up is a parallel system, then the parallel configurations must also be configured at initial power up. Please refer to the “Parallel Mode Setup and Startup” section under “Basic Operations” for the procedures for starting up a parallel system.

Display Menu Path	Parameters	Default Value	Options	Description
Settings/ Basic	Language	English	English	Select the language required for the UPS Display Interface. Language options vary by model and firmware version.
	Password	123456	6 digits	The password must be 6 characters, numbers only.
	Date and Time	2022-01-01 and 07:00:00	Date and time	Enter the current date and time.
Settings/ Advanced	Output Voltage	Depends on SKU	Depends on SKU	Set the output voltage for the UPS. This setting can only be changed when the UPS output is off.

Configure these settings at any time, using the UPS Display Interface or the Web UI.

Display Menu Path	Parameters	Default Value	Options	Description
Settings/ Basic	Language	English	English	Select the language required for the UPS Display Interface. Language options vary by model and firmware version.
	Password	123456	6 digits	The password must be 6 characters, numbers only.
	Display Brightness	63	10–63	Set the brightness of the display (10-63)
	Display Backlight Timeout	60 secs	10-255 secs	To conserve energy, the LCD back light illumination dims or turns off when no events are active. Full UPS Display Interface illumination

				returns when the UPS changes status because of an event or when the UPS Display Interface is pressed.
	Date and Time	2022-01-01 and 07:00:00	Date and time	Enter the current date and time.
Settings/Advanced/System Setup	Working Mode	Normal	Normal, ECO, CF	Set up the UPS working Mode
	System Configuration	Single	Single Parallel	Single is a single UPS in the system. Parallel is 2 to 4 UPSs in a system (available only on the 3-Phase UPS).
	Input: Output Phase	3:3	3:3 3:1	3-Phase IN and 3-Phase OUT or 3-Phase IN and single-Phase OUT (available only on the 3-Phase UPS).
	Battery Temperature Sensor	Disable	Enable Disable	An external sensor cable must be connected from the first EBP to the UPS.
Settings/Advanced/Parallel Setup	Parallel ID	1	1-4	Each UPS in a parallel system must have a unique ID.
	Parallel Basic Units	2	2-4	This is the number of UPS units in the system.
	Parallel Redundancy Units	0	1-3	The parallel system is setup for a redundancy parallel configuration, this is the ID number of UPS unit that is the redundant unit in the system (0 means no redundancy).
Settings/Advanced/Output Setup	Output Frequency	Auto	Auto, 50Hz, 60Hz	Set the output frequency for the UPS.
	Output Voltage	Depends on SKU	Depends on SKU	Set the output voltage for the UPS. This setting can only be changed when the UPS output is off.
	Inverter Voltage Adjustment	0%	-5% to +5%	Used for finetuning the output on UPS units in the parallel system (available only on the 3-Phase UPS).
	Bypass Up Limit	264V	230V-276V	Set the bypass up limit
	Bypass Down Limit	176V	176V-220V	Set the bypass down limit
	UPS Mode	Normal	Normal, ECO, CF, Parallel, Generator	Set the ups mode
	Bypass Function	Enable	Enable, Disable	Set the bypass function
Battery	Battery Group	1	1 to 5 Or 1 to 8	Set the number of EBP units connected to the UPS (single-phase UPS is 1-5 and 3-

				Phase UPS is 1-8).
	Boost/Float Conversion	3 Months	0 – 24 Months	Used for battery life optimization (available only on the 3-Phase UPS).
	Cell Float Voltage	2.25V	2.20-2.29V	Used for battery life optimization (available only on the 3-Phase UPS).
	Cell Boost Voltage	2.35V	2.30-2.45V	Used for battery life optimization (available only on the 3-Phase UPS).
	Boost Charge Setting	Enable	Enable, Disable	Used for battery life optimization (available only on the 3-Phase UPS).
	No Battery Warning	Enable	Enable, Disable	Allows warning to be disabled when there is no battery connected to the UPS.
	Shared Battery	Disable	Enable, Disable	For parallel system, this allows the charging circuit in multiple UPS units to charge the batteries in the system (available only on the 3-Phase UPS).
	EOD Group 2	1.75	1.75 1.84 1.92	Set Group 2 outlets to a battery cell voltage that will cause the outlets to automatically turn off when the UPS is in battery mode.
	EOD Group 3	1.75	1.75 1.84 1.92	Set Group 3 outlets to a battery cell voltage that will cause the outlets to automatically turn off when the UPS is in battery mode.
	Language	English	English Simplify Chinese	Select the language required for the UPS Display Interface. Language options will vary by model and firmware version.
Display	Audible Alarm	Loud	Disable Soft Medium Loud	Select the volume level for alarms when Enable is selected. When audible alarms are disabled, the UPS will never emit an audible alarm.
	Back Light Mode	Auto Dim	Always On Auto Dim Auto Off	To conserve energy, the LCD back light illumination dims or turns off when no events are active. Full UPS Display Interface illumination returns when the UPS changes status as a result of an event or when any button on the UPS Display Interface is pressed.
	Brightness	5	1-5	Adjust brightness and contrast for each LCD back light color.
	System Time	User Choice	Date and time	Enter the current date and time.

Appendix D: 10 to 20kVA Dry contact port definition

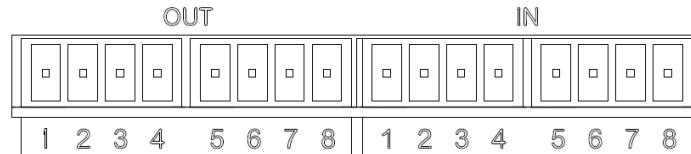

Input dry contact interface:

Port	Name	Function
IN-1	Input_contact_1	Input dry contact signal port (Select with LCD)
IN-2	GND	Input dry contact signal GND
IN-3	Input_contact_2	Input dry contact signal port (Select with LCD)
IN-4	GND	Input dry contact signal GND
IN-5	Input_contact_3	Input dry contact signal port (Select with LCD)
IN-6	GND	Input dry contact signal GND
IN-7	Input_contact_4	Input dry contact signal port (Select with LCD)
IN-8	GND	Input dry contact signal GND

Output Dry Contact Interface:

Port	Name	Function
OUT-1	Output_1_RLY	Output_1 dry contact port NC pin
OUT-2	Output_1_RLY_C	Output_1 dry contact port common pin
OU -3	Output_2_RLY	Output_2 dry contact port NC pin
OUT-4	Output_2_RLY_C	Output_2 dry contact port common pin
OUT-5	Output_3_RLY	Output_3 dry contact port NC pin
OUT-6	Output_3_RLY_C	Output_3 dry contact port common pin
OUT-7	Output_4_RLY	Output_4 dry contact port NC pin
OUT-8	Output_4_RLY_C	Output4 dry contact port common pin

Appendix E: 10 to 20kVA Backfeed protection port definition

Definition of male port:

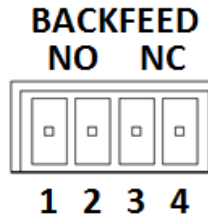

Instruction:

UPS	Instruction
Pin1/PIN2	Normally NO
Pin3/PIN4	Normally NC

Function description: Drive the bypass breaker when Backfeed alarm.

Appendix F: 10 to 20kVA REPO port definition

Connection diagram:

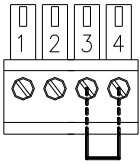
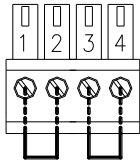
EPO	EPO Wiring Diagram	Function
EPO-NC (Default)		<ol style="list-style-type: none"> 1. Remove the wire jumper between terminals 3 & 4. 2. Connect wires from the Normally Closed (NC) contact of the EPO switch/relay. <p>The EPO function will be triggered when the wire jumper between pins 3 and 4 is removed or the EPO contact changes to Normally Open (NO).</p>
EPO-NO		<ol style="list-style-type: none"> 1. Connect wires from the Normally Open (NO) contact of the EPO switch/relay. <p>The EPO function will be triggered when wire jumper between terminals 3 and 4 is removed or the EPO switch/relay contact changes to NC.</p>

Connection between the button and UPS REPO port.

A remote emergency stop switch can be installed in a remote location and connection through simple wires to the REPO connector.



Sales, Marketing, Technical and Channel representative of Panduit in Middle East & Africa.
info@itrident.com
www.itrident.com