

smartzone[™] UPS

User Manual

Uninterruptible Power Supply

1-3KVA (SINGLE PHASE)

Table of Contents

Section 1 – System Overview	2
Key Features	3
Basic Operations	4
UPS Overview	4
UPS Working Modes	4
UPS Physical Features and Options	9
Physical Features	9
UPS Options	16
Section 2 – Front Panel Display (FPD).....	22
Status LEDs.....	22
Function Buttons	23
Color Display Operation	24
Monitoring Operation.....	24
Settings Operation.....	27
Appendix A: 1 to3kVA Fault/Alarm Codes.....	31

Section 1 – System Overview

The Panduit SmartZone™ UPS units are true on-line double conversion systems that deliver highly efficient and reliable power protection for your computer, IT, communications, and automatic equipment. These units have high electrical performance, intelligent monitoring, and network functions to properly monitor and condition the world's power problems (power failures, power sags, power surges, under-voltages, over-voltages, electrical line noises, frequency variations, switching transients, and harmonic distortion).

Each UPS has multiple options for interfacing with the unit. The UPS can be ordered with a network card for remote network monitoring, control, and configuration, or can be ordered without a network card. Additionally, a Network Card or a Dry Contact Relay Card can be ordered as accessories.

Each UPS unit is also equipped with a serial port for limited local monitoring, control, and configuration through a PC. This manual provides the information on how to operate the system with all interfacing options.

The UPS units support VRLA (Value Regulated Lead-acid) batteries as the backup power storage system. The topology of these units is on-line double conversion with a built-in economy (ECO) mode. The on-line double conversion architecture provides the best power conditioning by recreating a true sinewave on the UPS outputs. The on-line double conversion topology converts the input AC power to a DC power and then regenerates the AC power on the UPS outputs. This double conversion allows the UPS to eliminate the inconsistencies in the input power, provided by the utility company. The UPS may be optionally switched to ECO mode to increase the unit's efficiency when the input power is known to be reliable (requires minimal conditioning).

All UPS units described in this User Manual have a 2.8-inch segment color display. The screen can be manually rotated to support horizontal in-rack installation or vertical tower installation.

Key Features

- Integrated data center solution - UPS integrates with multiple External Battery Packs (EBP) and an external Maintenance Bypass Switch (MBS), offering an excellent choice for data center deployment.
- Digital Control - These UPS units controlled by Digital Signal Processor (DSP) which increases reliability, performance, self-protection, and self-diagnostics.
- Configurable Battery Charging Current - the user may set the battery's charging parameters to optimize battery utilization and battery life.
- Intelligent Charging Method - The UPS units have an advanced three-stage charging method to extend the battery life and guarantee fast charging.
 - 1st stage: constant current charging to guarantee to charge back to 90%.
 - 2nd-stage: constant voltage charging to make sure batteries are fully charged.
 - 3rd stage: float voltage charging to ensure the battery stays charged to the optimal level.
- User Friendly Front Panel Display – Segmented Color Display with Color Status LEDs allow the user to easily get UPS status and set operational parameters.
- Intelligent Monitoring Function – Standardly equipped with a Network card for remotely controlling and monitoring the UPS via a user-friendly Web Interface.
- EPO Function - These UPS units are all equipped with an Emergency Power Off (EPO) interface to shut OFF the UPS via a remote switch.

Basic Operations

The basic operations of a double conversion UPS are explained through the high-level block diagram in Figure 1.

UPS Overview

The input of the UPS is connected to an AC power source via an input plug or a hardwire connection (depending on the UPS unit purchased). The output is connected to loads via outlets or a hardwire connection on the UPS (depending on the UPS unit purchased). The AC power source for the loads is provided by the output(s) on the UPS.

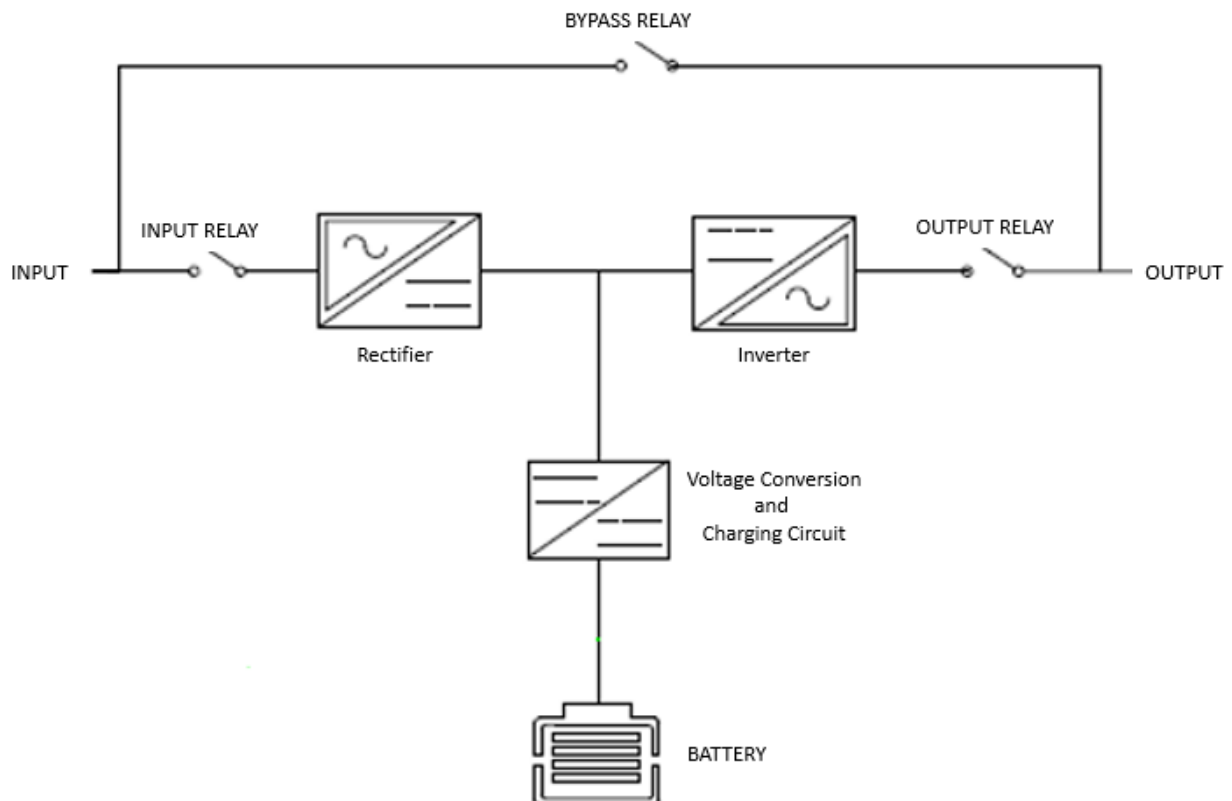

Figure 1: High-level Double Conversion UPS Block Diagram

UPS Working Modes

This section provides an explanation of the working modes that the UPS may be in at any given time. The UPS may be manually configured to operate in certain modes. The UPS may automatically transition to some of these working modes because of an internal or external event.

Normal Mode

Normal mode (on-line double conversion) is the default working mode of the UPS unit. When the UPS is operating in normal mode it provides a stable pure sinusoidal AC power output and charges the battery. In normal mode the input and output relays are closed, and the bypass (ECO) relay is open. The rectifier/charger derives power from the AC Input and supplies DC power to the inverter while simultaneously boost/float charging the battery. The inverter converts the DC power to AC and supplies to the load with a stable pure sinusoidal AC power.

If input power is lost while the UPS is operating in normal mode, the UPS automatically transition to battery mode. In battery mode the battery will stop charging and start providing the DC power to the DC to AC inverter, continuing to provide AC power to the load.

If an internal fault or an overload occurs while operating in normal mode, the UPS automatically transitions to bypass mode. In bypass mode the input and output relays open and the bypass relay closes, continuing to provide unconditioned AC power to the load.

ECO Mode

When the UPS is in Normal Mode and the requirement to the load is not critical, the UPS can be set at ECO mode to increase the efficiency of the power supplied. When the UPS is manually be configured for Energy Savings (ECO) mode, the output replay opens, and the bypass relay closes. The input relay remains closed, continuing to keep the VLRA backup batteries charged. In ECO mode, the UPS works at Line-interactive UPS. In ECO mode the source power is not fully conditioned as in normal mode.

If the input power is lost while the UPS is operating in ECO mode, the batteries will stop charging, the bypass relay will open, the output relay will close and the battery will start providing the DC power to the DC to AC inverter, continuing to provide AC power to the load.

If an internal fault or overload occurs while operating in ECO mode, the bypass relays will open and the output will shut down, AC power to the load will be lost.

Convert Frequency (CF) Mode

By default, CF mode is not enabled. This mode may be manually enabled. When this mode is enabled, the UPS may be used in a condition where the output frequency needed does not match the input frequency. When 50Hz input frequency is converted to 60Hz on the output, the UPS output must be derated to 75%. When 60Hz input

frequency is converted to 50Hz on the output, no UPS derating is required. When this mode is enabled, the bypass mode is automatically disabled (the unit cannot switch to bypass mode under any conditions). CF mode works in conjunction with normal mode only.

If input power is lost while the UPS is operating in CF mode, the UPS automatically transitions to battery mode. In battery mode the battery will stop charging and start providing the DC power to the DC to AC inverter, continuing to provide AC power to the load.

If an internal fault or overload occurs while operating in CF mode, the output relays will open and the output will shut down, AC power to the load will be lost.

Generator Mode

By default, generator mode is not enabled. This mode may be manually enabled. This mode enables the UPS to have a wider input frequency range (40Hz to 70Hz). When this mode is enabled the UPS output must be derated to 70% of the maximum output. Note: Generator mode is not a settable option on the 3-Phase UPS units because these units always operate with a wider frequency range; 3-phase UPS units always operate in generator mode with no derating. Generator mode works in conjunction with normal or ECO mode. NOTE: If operating in ECO mode and generator mode is enabled, ensure that the loads can support the 40 to 70Hz frequency variations.

The generator mode will not be saved. When the UPS is powered off and restarted, it will automatically return to Normal mode.

If input power is lost while the UPS is operating in generator mode, the UPS automatically transition to battery mode. In battery mode the battery will stop charging and start providing the DC power to the DC to AC inverter, continuing to provide AC power to the load. After the generator starts providing stable power, the UPS will automatically transition back to normal or ECO mode, whichever mode was configured on the UPS.

If an internal fault or overload occurs while operating in generator mode, the UPS will follow the conditions stated above for either normal mode or ECO mode depending on the working mode configured in the UPS.

NOTE: Generator Mode will not be saved when the UPS is powered OFF and restarted. Generator mode will need to be enabled again on the 5-10kVA single phase UPS units.

Battery Mode

The UPS automatically transitions into battery mode with no power interruption when input voltage is abnormal or is lost. The UPS may manually be put into battery mode, indirectly, by manually running the battery test. The UPS will automatically return to Normal Mode when the input sources recover.

If an internal fault or overload occurs while operating in battery mode, the output relays will open and the output will shut down, AC power to the load will be lost.

Bypass Mode

The UPS automatically transitions into bypass mode with no power interruption when an internal fault or output overload occurs. The UPS can also be set to bypass mode by turning OFF the inverter (press the ON/OFF button on the Front Panel Display), but the input voltage and frequency must be within the specified ranges as specified in settings. In bypass mode the source power is not fully conditioned as in normal mode.

If an internal fault or overload occurs while operating in bypass mode, the output relays will open and the output will shut down, AC power to the load will be lost.

If input power is lost while operating in bypass mode, the output relays will open and the output will shut down, AC power to the load will be lost.

Maintenance Bypass Mode

The UPS may be switched into maintenance bypass mode to perform periodic maintenance on the UPS. The maintenance bypass switch will electrically disconnect the UPS from the system. When the UPS is switched to maintenance bypass mode the CB1, CB2 and CB4 are opened, and CB3 is closed. In maintenance bypass mode the source power is not conditioned as in normal mode. NOTE: Maintenance bypass mode is supported on the 3-Phase UPS units only.

If input power is lost while operating in maintenance bypass mode, AC power to the load will be lost.

Fault Mode

The UPS automatically transitions into fault mode when the UPS is unable to provide power to the load. The input, output and bypass relays are all open.

Battery Test Mode

The UPS may be manually or automatically put into the battery test mode, but the UPS will automatically transition back to the previous mode when the test is complete. The battery test may be manually executed at any time. The battery test may also be

scheduled to automatically run at a predetermined interval. As part of executing the battery test, a test duration must be specified.

The frequency and duration of the battery test have an impact on the battery life. A longer test duration will provide more accurate results but will cause the UPS to have a longer recovery time (battery charge will be farther depleted and it will take longer to charge the battery to allow the UPS to provide the specified run time when needed).

UPS Physical Features and Options

The following sections provide an overview of the human and electrical interfaces on the UPS unit. All UPS units are rack mountable with a display on the front side of the unit.

Physical Features

UPS Front Panel

The UPS Front Panel for all 1to3kVA Models are the same. The front panel contains four status LEDs, a 2.8-inch segmented color display and four function buttons.

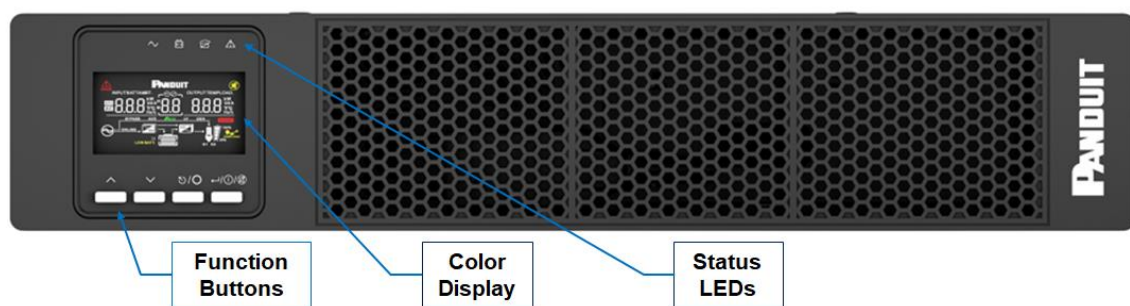

Figure 3: 1to3kVA Front Panel

Status LEDs

Each unit has four Status LEDs that provide a quick high-level view of the units operating conditions.

- Normal LED (Green sinewave) – indicates the unit is operating in normal mode.
- Battery LED (Yellow battery) – indicates the unit is operating in battery mode.
- Bypass LED (Blue bypass)– indicates the unit is operating in bypass mode.
- Alert LED (Red or Yellow)– Red indicates that the unit has an active Fault, yellow indicated the unit has an active Alarm..

Color Display

The unit has a 2.8-inch segment color display. This display is used for monitoring, control, and configuration. The display can be physically rotated to the orientation of the unit.

Function Buttons

The UPS has four function buttons, the Up function, the down function, the off/cancel function, and the on/enter function button. The buttons are used to navigate through the display pages, the configuration pages, used to change modes and turn on/off the UPS.

UPS Rear Panel

The rear side of the unit varies based on the part number of the unit. Refer to the UPS Physical Feature call out table and the Model specific figures in the section for details.

1to3kVA 1-Phase UPS Physical Feature Call Out Table:

1. Input Power Cord	4. EBP Connection	7. EPO Signal Port
2. Input Circuit Breaker	5. Intelligent Slot	8. RS232 Communication
3. Output Receptacles	6. Net Surge Protection Ports	9. USB Communications

Input Power Cord

Each UPS Model may have unique power input connector, labeled INPUT. Refer to the corresponding Product Specification Sheet for detailed definition.

Input Circuit Breaker

All UPS have a input circuit breaker, labeled BREAKER, to protect for over load conditions

Output Receptacles

Each UPS Model may have unique power output connector, labeled GROUP 1 or GROUP 2. The following sections defined typical output receptacles, however, refer to the corresponding Product Specification Sheet for latest detailed definition.

EBP Connection

All units have an External Battery Pack (EBP) power connection, labeled, 24VDV or 36VDC or 48VDC or 72VDC. Each UPS Model has been calibrated to a specific EBP and EBP Operating Voltage and are not interchangeable due to the operating voltage.

Intelligent Slot

The UPS can be ordered equipped with a Network management Card. Alternatively, the UPS may be ordered with an empty Intelligent Slot, and latter updated with a UPS Network Management Card or a UPS Relay Card

Net Surge Protection Ports

The UPS comes equipped with an internal Network/Fax/Modem Surge protection. The featured includes 1 RJ45 Input port and 1 RJ45 Output port.

EPO Signal Port (EPO)

All units have an Emergency Power Off Signal Port, labeled EPO. This UPS comes equipped with a 2 pin plug wired to provide a short that results in normal UPS operation. Caution, if the plug is removed, The UPS system will be commanded to shut down. In

typical applications, the plug will be removed, and the UPS will be wired to a remote source to provide a short for normal operation or open circuit to command the UPS to shut down.

RS232 Communication (RS232)

All units have a DB9 equipped with RS232 serial communications. This serial communications port provides basic monitoring and control.

USB Communication (USB or USB symbol)

The UPS includes USB serial communications. This communication port is reserved for factory support.

Chassis Ground Connection Point (ground symbol)

All units have a chassis ground connection, labeled with a ground symbol. This ground signal is used to ground the UPS chassis to the rack/cabinet. For safety and proper grounding reasons, the connection must be connected to the rack/cabinet ground.

1kVA North America Models Rear Panel (U01x11V/ U01x13V)

The 1kVA North American (NA) UPS unit has a permanently connected input power cord with a NEMA 5-15 plug. This unit has two groups of outlets. Group 1 (4x 5-15R) outlets are the main outlets that are not switchable, these outlets should contain the critical loads. Group 2 (2x 5-15R) are switchable outlets, these outlets should contain the non-critical loads. During battery backup mode these outlets may be turned off earlier to conserve battery capacity for the Group 1 outlets.

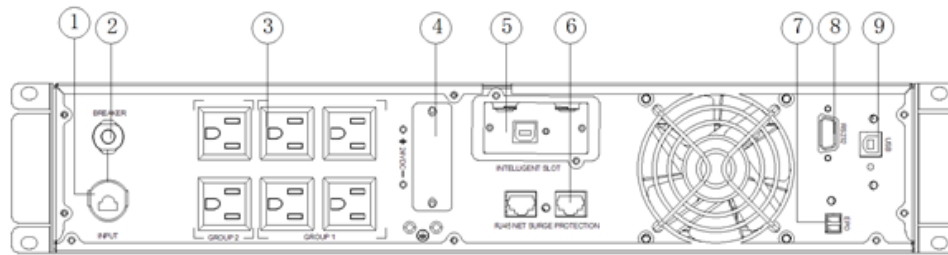

Figure 4: 1kVA NA Rear Panel View

2kVA North America Models Rear Panel (U02x11V)

The 2kVA NA UPS unit has a permanently connected input power cord with a NEMA 5-20 plug. This unit has two groups of outputs. Group 1 (4x 5-20R) outlets are the main outlets that are not switchable, these outlets should contain the critical loads. Group 2 (2x 5-20R) are switchable outlets, these outlets should contain the non-critical loads. During battery backup mode these outlets may be turned off earlier to conserve battery capacity for the Group 1 outlets.

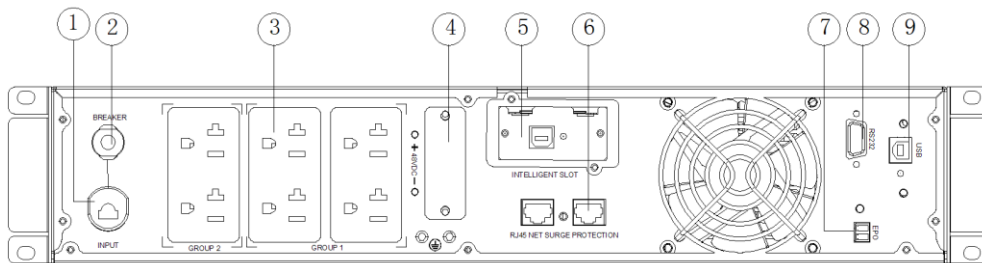

Figure 5: 2kVA NA Rear Panel View

3kVA North America Models Rear Panel (U03x11V)

The 3kVA NA UPS unit has a permanently connected input power cord with a NEMA L5-30 plug. This unit has two groups of outputs. Group 1 (2x 5-20R and 1xL5-30R) outlets are the main outlets that are not switchable, these outlets should contain the critical loads. Group 2 (2x 5-20R) are switchable outlets, these outlets should contain the non-critical loads. During battery backup mode these outlets may be turned off earlier to conserve battery capacity for the Group 1 outlets.

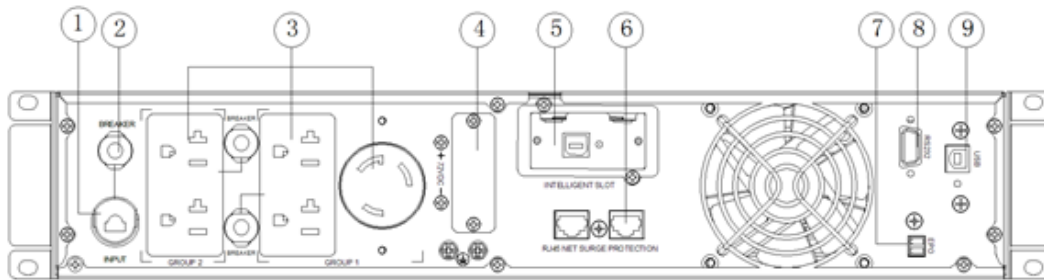

Figure 6: 3kVA NA Rear Panel View

1kVA Europe Models Rear Panel (U01x12V)

The 1kVA European (EU) UPS unit has a power cord with Schuko CEE 7/EU1-16P and BS1363A on either end to connect the input of the UPS and to a wall outlet. This unit has two groups of outputs. Group 1 (4xC18) is the main non-switchable output; this output should contain the critical loads. Group 2 (4xC18) are switchable outlets, these outlets should contain the non-critical loads. During battery backup mode these outlets may be turned off earlier to conserve battery capacity for the Group 1 output.

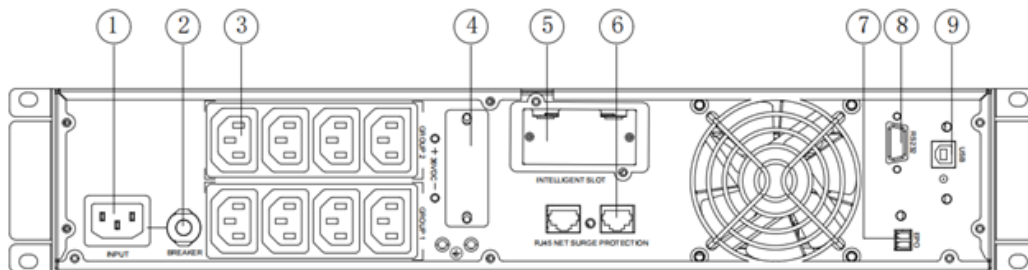

Figure 7: 1kVA EU Rear Panel View

2kVA Europe Models Rear Panel (U02x12V)

The 2kVA EU UPS unit has a power cord with Schuko CEE 7/EU1-16P and BS1363A on either end to connect the input of the UPS and to a wall outlet. This unit has two groups of outputs. Group 1 (4xC18) is the main non-switchable output; this output should contain the critical loads. Group 2 (4xC18) are switchable outlets, these outlets should contain the non-critical loads. During battery backup mode these outlets may be turned off earlier to conserve battery capacity for the Group 1 output.

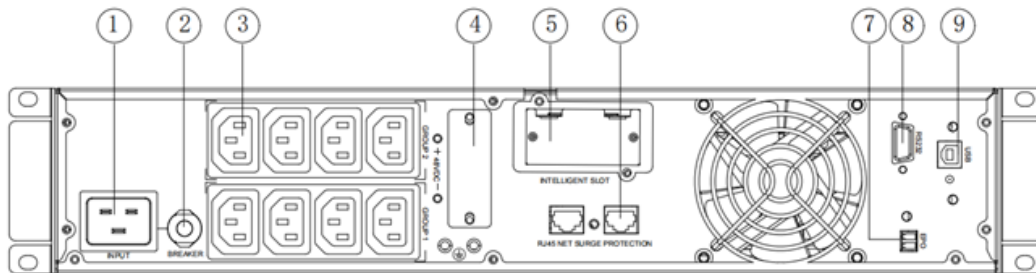

Figure 8: 2kVA EU Rear Panel View

3kVA Europe Models Rear Panel (U03x12V)

The 3kVA EU UPS unit has a power cord with Schuko CEE 7/EU1-16P and BS1363A on either end to connect the input of the UPS and to a wall outlet. This unit has two groups of outputs. Group 1 (4xC18 and 1xC19) is the main non-switchable output; this output should contain the critical loads. Group 2 (4xC18) are switchable outlets, these outlets should contain the non-critical loads. During battery backup mode these outlets may be turned off earlier to conserve battery capacity for the Group 1 output.

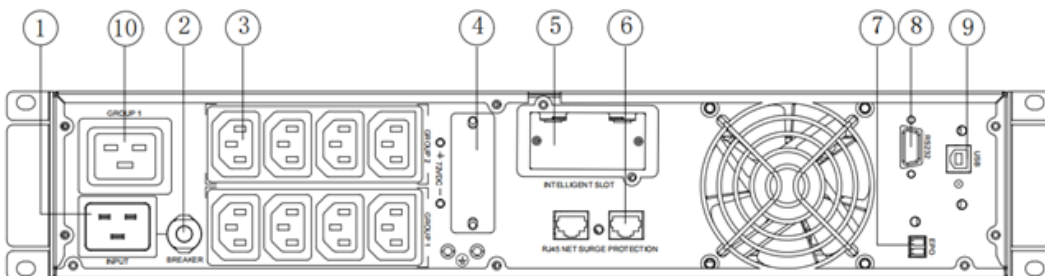

Figure 9: 3kVA EU Rear Panel View

UPS Options

External Battery Pack

The UPS comes with one External Battery Pack (EBP). Additional EBPs may be connect to the UPS to extend the runtime of the UPS when operating in battery mode. The single-phase 5-10kVA UPS units support up to five EBPs. The 3-phase 10-20kVA UPS units support up to eight EBPs.

The EPB has a positive-negative dual-battery structure. The single-phase 5-10kVA UPS units support a 240V battery pack. This battery pack has a total of 20 batteries connected in series. The 3-phase 10-20kVA UPS units support a 480V battery pack. This battery pack has a total of 40 batteries connected in series. In Figure 12 a neutral wire is drawn from the connection between the negative lead of the 10th (or 20th) battery and the positive lead of the 11th (or 21st) battery. A total of three wires are connected to the UPS unit, the positive and negative ends of the battery pack and a neutral line. The battery cartridge between the positive end of the battery pack and the neutral line of the battery pack is called a positive battery, and the battery cartridge between the negative end of the battery pack and the neutral line of the battery pack is called a negative battery. The positive and negative battery in series makes up the total EBP battery.

The BAT+ is connected to the positive lead of the positive battery, BAT-N is connected to the negative lead of the positive battery and the positive lead of the negative battery, and BAT- is connected to the negative lead of the negative battery.

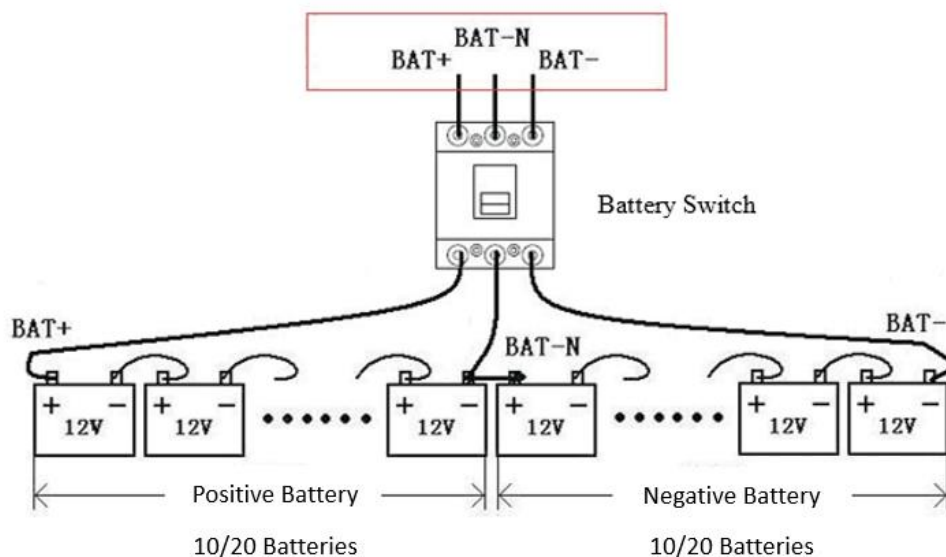

Figure 12: External Battery Pack Configuration

The factory setting for the number of batteries is preset to 20 or 40 depending on the EBP (P/N UVP240 or P/N UVP480). Note: When additional EBPs are connected to the UPS the number of EBPs must be appropriately set. All relevant settings may be performed through the WebUI or the Front Panel Display.

Warning!



Ensure that the polarities are correctly connected to the UPS unit and to subsequent EBP units. The battery cartridges cannot be mixed, please use the Panduit recommended battery cartridges sets (P/N UVD240 or P/N UVD480) for the appropriate EBP. Battery cartridges must be changed in sets. Do not mix old and new battery cartridges.

Maintenance Bypass Switch

The Maintenance Bypass Switch is an optional 3 RU unit that allows the 3-phase UPS unit to be removed from the system without powering down the load. The UPS has two sensor ports. The MAINT port allows the UPS to monitor the Maintenance Switch lock (on CB 3). The OUTPUT port allows the UPS to monitor the position of the output breaker (CB 4) in the Maintenance Bypass Switch unit.

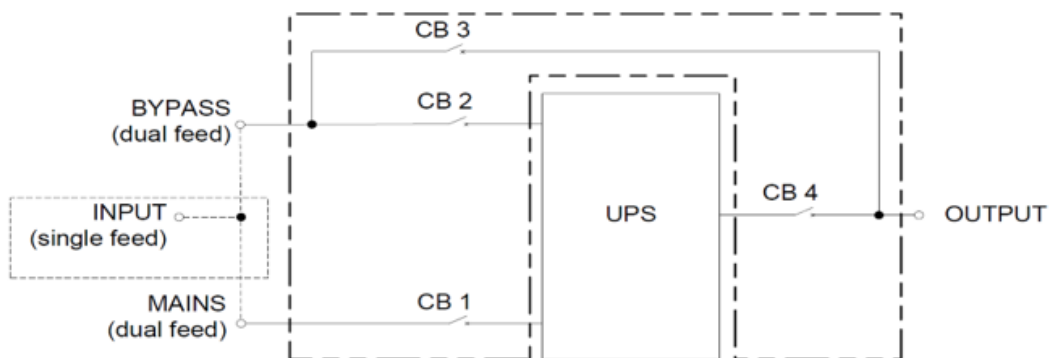

Figure 13: High-level Maintenance Bypass Switch Block Diagram

Network Card

The network card comes installed in the “N” type model UPS units (ex. U05N11V, U10N12V, U20N32V, etc.). Refer to Section 3 for monitoring and controlling the UPS through the Network card. The “S” type model UPS units (ex. U05S11V, U10S12V, U20S32V, etc.) may be upgraded with a network card or a relay card.



CAUTION! DO NOT TOUCH THE NETWORK CARD WITHOUT PROPER ESD PROTECTION.

Network Card Hardware Features

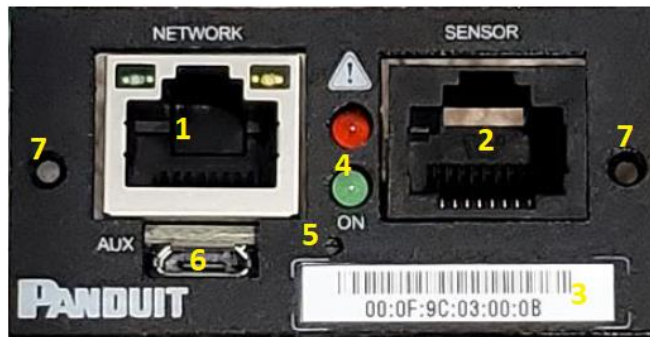

Figure 14: Network Card Front View

1. Ethernet Connection	3. MAC ID Label	6. Micro USB Connection
2. Sensor Connection	4. Status LEDs	7. Mounting holes
	5. Reset button	

Ethernet Connection

Connect the ethernet port on the Network card to an ethernet switch or router using a standard Cat 5E or Cat 6 ethernet cable.

Sensor Connection

Connect the supports Panduit environmental sensors and/or sensor hub with the cables provided in the sensor installation kit.

MAC ID Label

The MAC ID of the wired ethernet port is listed on the label on the faceplate of the Network card. The MAC ID is unique to the specific Network card.

Status LEDs

The red status LED turns on automatically as soon as power is applied. After the Network card initializes, the firmware in the Network card takes control of these LEDs. In general, the green LED indicates power to the Network card and the red LED indicates a fault on the Network card.

Reset Button

A pin hole is provided in the faceplate of the Network card to access the reset button

using a paper clip or similar device. The behavior of the Network card is provided in the table below and is dependent on the duration of the button press.

RESS DURATION	FUNCTION
>8 Seconds	Soft Reset to Restart/Reboot NMC
>20 Seconds	Hard Reset to Reset factory default settings of NMC

Micro USB Connection

The USB connector provides a COM port connection for a command line interface (CLI) to the Network card.

Relay Card

The intelligent slot on the UPS unit may accept the relay card or the Network card, not both. The relay card would typically not be used in the 3-phase UPS units since these units have dry contact points built into the unit. Follow the steps in the Network card section to install or remove the relay card from the UPS unit.

The 12-pin plus 2 terminal relay card allows the user to monitor specific status on the UPS and enable a remote UPS shutdown. The predefined monitoring contact points on the relay card change state when the status in the UPS changes state.

Terminal NO.	Terminal function	Description
1	Common source	common point for all contacts on the relay card
2	UPS ON = Open	When the UPS is switched ON, Pin 1 to Pin 2 would change from NC (Normal Closed) to Open.
3	AC fail = Open	When the input utility power fails, Pin 1 to Pin 3 would change from NC (Normal Closed) to Open.
4	AC fail = Close	When the input utility power fails, Pin 1 to Pin 4 would change from NO (Normal Opened) to Close.
5	Batt low = Open	When the battery voltage is low, Pin 1 to Pin 5 would change from NC (Normal Closed) to Open.
6	Batt low = Close	When the battery voltage is low, Pin 1 to Pin 6 would change from NO (Normal Opened) to Close.
7	UPS alarm = Open	When the UPS has an alarm, Pin 1 to Pin 7 would change from NC (Normal Closed) to Open.
8	UPS alarm = Close	When the UPS has an alarm, Pin 1 to Pin 8 would change from NO (Normal Opened) to Close.
9	Bypass active = Open	When the UPS is working in Bypass mode, Pin 1 to Pin 9 would change from NC (Normal Closed) to Open.
10	Bypass active = Close	When the UPS is working in Bypass mode, Pin 1 to Pin 10 would change from NO (Normal Opened) to Close.
11	UPS fault = Open	When the UPS has a fault, Pin 1 to Pin 11 would change from NC (Normal Closed) to Open.
12	UPS fault = Close	When the UPS has a fault, Pin 1 to Pin 12 would change from NO (Normal Opened) to Close.

The relay card contains eleven dry contact outputs plus common and one dry contact input plus ground. The input and outputs are factory programmed according to functions listed in the table below.



Figure 16: Relay Card Front and Top View (showing connection points)

Section 2 – Front Panel Display (FPD)

The UPS Front Panel for all 1to3kVA Models are the same. The front panel contains four status LEDs, a 2.8-inch segmented color display and four function buttons.

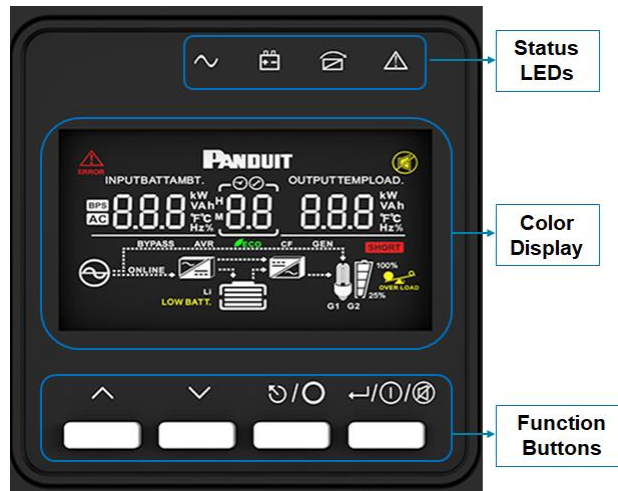





Figure 17: Front Panel Display (FPD)

Status LEDs

Each unit has four Status LEDs that provide a quick high-level view of the units operating conditions.

LED Icon	LED Name	Color - Operating Condition
	Alert LED	Yellow – Unit has Active Alarm, Red - Unit has Active Fault
	Bypass LED	Blue - UPS is in bypass mode
	Battery LED	Yellow - UPS in battery mode
	Normal LED	Green - UPS in normal mode (Unit has AC input power)

Function Buttons

Button Icon	Button Name	Function Description
	UP	<ul style="list-style-type: none"> • Press to Display previous selection
	DOWN	<ul style="list-style-type: none"> • Press to Display next selection • In Settings Mode, press to save setting selection and exit settings mode
	CANCEL / OFF	<ul style="list-style-type: none"> • In Battery Mode, press for 3 seconds to turn off UPS • In Normal Mode, press for 3 seconds to change to Bypass Mode • In Settings Mode, press to exit settings mode without changing settings
	ENTER / ON	<ul style="list-style-type: none"> • With UPS Off, press for 3 seconds to turn on UPS • In Setting Mode, press to Confirm setting value • In Bypass Mode, press and Hold change to Normal Mode

Color Display Operation

The display has 2 types of operations. It has a Monitoring operation, and a settings operation.

Monitoring Operation

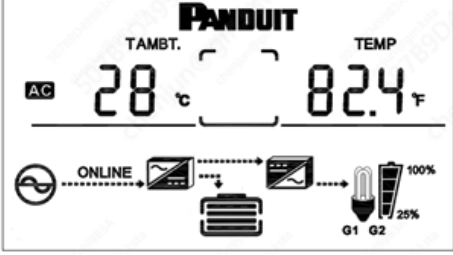
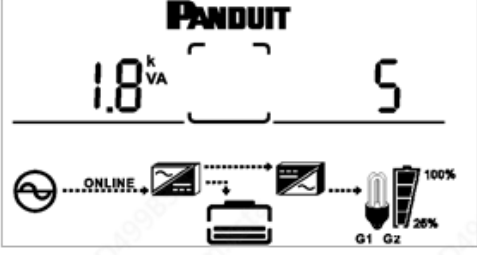
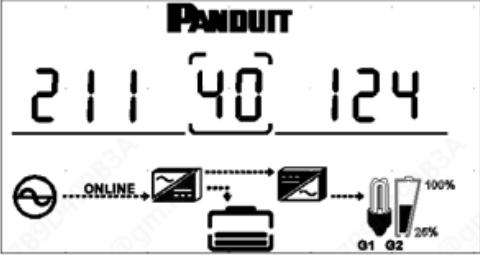
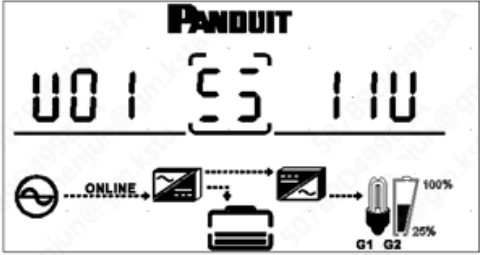

Screen #	Parameter(s) Name(s)	Example Display Content
M-01	Input voltage & Output voltage	
M-02	Battery voltage, & Battery hold time & Battery capacity %	
M-03	Input frequency & Output frequency	
M-04	Current Load Actual Power (kW) & Apparent power (kVA)	

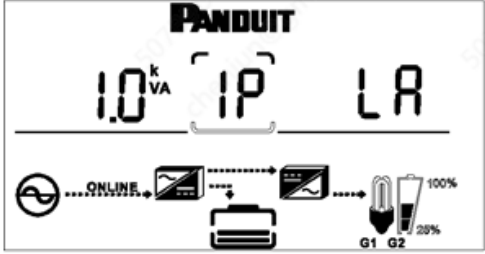
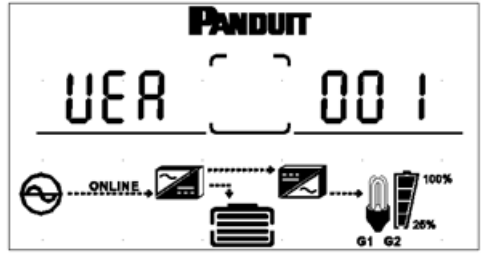
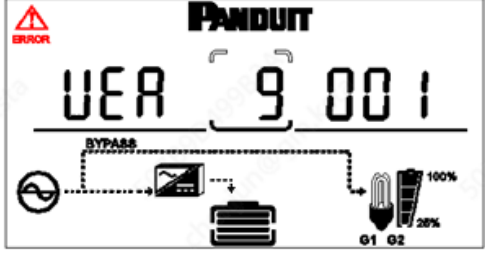

Screen #	Parameter(s) Name(s)	Example Display Content
M-05	Ambient Temperature (°C & °F)	
M-06	UPS Model.	
M-7	UPS Serial Number Suffix	
M-8	UPS Part Number	

Screen #	Parameter(s) Name(s)	Example Display Content
M-9	SKU Number	 <p>The screenshot shows the PANDUIT logo at the top. Below it, the display shows '1.0^{kVA}' followed by 'IP' in brackets and 'LA'. At the bottom, there is a status bar with an 'ONLINE' indicator, a battery icon, and two battery level gauges labeled 'G1' and 'G2'. G1 is at 100% and G2 is at 20%.</p>
M-10	Firmware Version	 <p>The screenshot shows the PANDUIT logo at the top. Below it, the display shows 'UER' followed by a bracketed space and '00 1'. At the bottom, there is a status bar with an 'ONLINE' indicator, a battery icon, and two battery level gauges labeled 'G1' and 'G2'. G1 is at 100% and G2 is at 20%.</p>
M-11	Error Code (Alarm/Faults)	 <p>The screenshot shows the PANDUIT logo at the top. In the top left corner, there is a red triangle with the word 'ERROR'. Below the logo, the display shows 'UER' followed by a bracketed '9' and '00 1'. At the bottom, there is a status bar with a 'BYPASS' indicator, a battery icon, and two battery level gauges labeled 'G1' and 'G2'. G1 is at 100% and G2 is at 20%.</p>

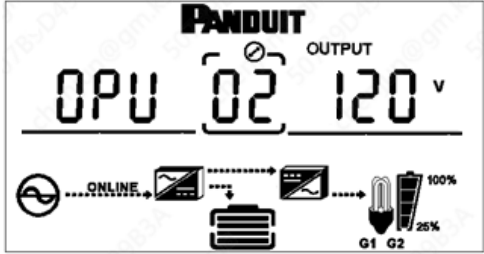
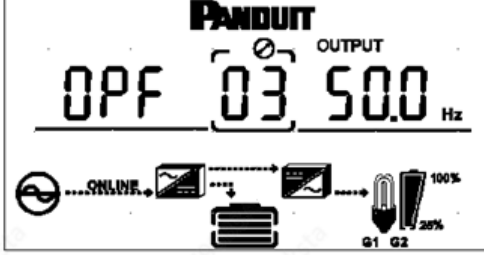
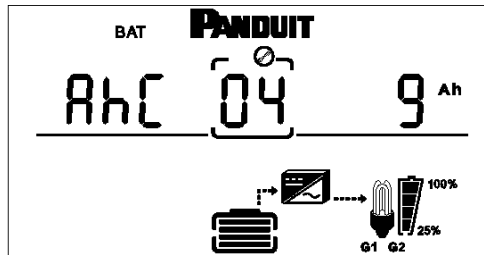
Settings Operation

Screen #	Settings	Content display
S-01A	<p>Mode setting (Normal view)</p> <ul style="list-style-type: none"> • ENTER to change setting • UP ▲ for previous setting • DOWN ▼ for next setting • CANCEL to exit no change 	
S-01B	<p>Mode setting (CF view)</p>	
S-01C	<p>Mode setting (GEN mode)</p>	
S-01D	<p>Mode setting (ECO mode)</p>	

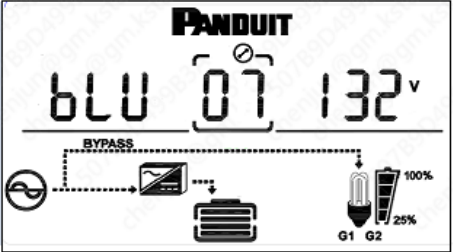
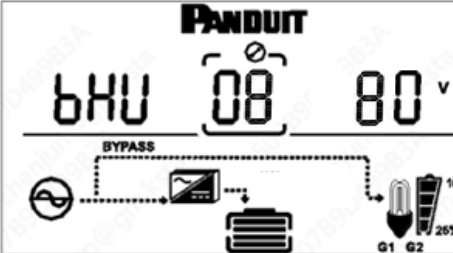
Screen #	Settings	Content display
S-02	<p>Output Voltage Setting (110, 115, 120)</p> <ul style="list-style-type: none"> • ENTER to change setting • UP ▲ for previous setting • DOWN ▼ for next setting • CANCEL to exit no change 	
S-03	<p>Frequency setting (50 or 60Hz)</p> <ul style="list-style-type: none"> • ENTER to change setting • UP ▲ for previous setting • DOWN ▼ for next setting • CANCEL to exit no change 	
S-04	<p>Battery capacity setting (1-200Ah)</p> <ul style="list-style-type: none"> • ENTER to change setting • UP ▲ for previous setting • DOWN ▼ for next setting • CANCEL to exit no change 	
S-05	<p>Group 2 Battery EOD voltage setting (1.75/1.84/1.92)</p> <ul style="list-style-type: none"> • ENTER to change setting • UP ▲ for previous setting • DOWN ▼ for next setting • CANCEL to exit no change 	
S-06	<p>Group 1 Battery EOD voltage setting (1.65/1.7/1.75/1.8)</p> <ul style="list-style-type: none"> • ENTER to change setting • UP ▲ for previous setting • DOWN ▼ for next setting • CANCEL to exit no change 	

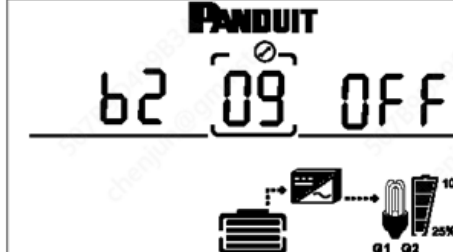
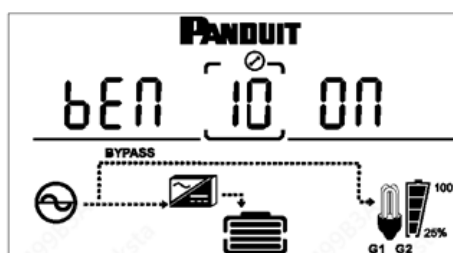
Screen #	Settings	Content display
S-07	<p>Bypass voltage upper limit setting (120-132Vac)</p> <ul style="list-style-type: none"> • ENTER to change setting • UP▲ for previous setting • DOWN▼ for next setting • CANCEL to exit no change 	 <p>The screenshot shows the 'PANDUIT' logo at the top. Below it, the display reads 'BLU 07 132V'. A diagram below the display shows a bypass path from an AC source through a bypass switch to a load, bypassing the UPS. To the right, there are two battery level indicators labeled 'G1' and 'G2', with '100%' and '25%' respectively.</p>
S-08	<p>Bypass voltage lower limit setting (80-110Vac)</p> <ul style="list-style-type: none"> • ENTER to change setting • UP▲ for previous setting • DOWN▼ for next setting • CANCEL to exit no change 	 <p>The screenshot shows the 'PANDUIT' logo at the top. Below it, the display reads 'BLU 08 80V'. A diagram below the display shows a bypass path from an AC source through a bypass switch to a load, bypassing the UPS. To the right, there are two battery level indicators labeled 'G1' and 'G2', with '100%' and '25%' respectively.</p>
S-09A	<p>Mute setting (ON view)</p> <ul style="list-style-type: none"> • ENTER to change setting • UP▲ for previous setting • DOWN▼ for next setting • CANCEL to exit no change 	 <p>The screenshot shows the 'PANDUIT' logo at the top. Below it, the display reads 'b2 09 ON'. A diagram below the display shows a bypass path from an AC source through a bypass switch to a load, bypassing the UPS. To the right, there are two battery level indicators labeled 'G1' and 'G2', with '100%' and '25%' respectively. A yellow speaker icon in the top right corner indicates that the buzzer is on.</p>
S-09B	<p>Mute setting (OFF view)</p> <ul style="list-style-type: none"> • Buzzer will be muted, even with new Alerts. 	 <p>The screenshot shows the 'PANDUIT' logo at the top. Below it, the display reads 'b2 09 OFF'. A diagram below the display shows a bypass path from an AC source through a bypass switch to a load, bypassing the UPS. To the right, there are two battery level indicators labeled 'G1' and 'G2', with '100%' and '25%' respectively. A yellow speaker icon in the top right corner is crossed out, indicating that the buzzer is muted.</p>
S-10A	<p>BYPASS Setting (Bypass enabled view)</p> <ul style="list-style-type: none"> • ENTER to change setting • UP▲ for previous setting • DOWN▼ for next setting • CANCEL to exit no change 	 <p>The screenshot shows the 'PANDUIT' logo at the top. Below it, the display reads 'bEN 10 ON'. A diagram below the display shows a bypass path from an AC source through a bypass switch to a load, bypassing the UPS. To the right, there are two battery level indicators labeled 'G1' and 'G2', with '100%' and '25%' respectively.</p>

Screen #	Settings	Content display
S-10B	<p>BYPASS Setting (Bypass disabled view)</p> <ul style="list-style-type: none"> • ENTER to change setting • UP ▲ for previous setting • DOWN ▼ for next setting CANCEL to exit no change 	 <p>The LCD display shows the word 'PANDUIT' at the top. Below it, the text 'bEN 10 OFF' is displayed in a large font. At the bottom of the screen, there is a battery status indicator showing two bars labeled 'G1' and 'G2', with a percentage of 25% and a 100% mark. To the left of the battery indicator, there are icons for a power source and a battery pack.</p>

Appendix A: 1 to3kVA Fault/Alarm Codes

The following Error Code Tables list the available Fault and Alarm codes shown on the display of the 1 to 3VA 1-Phase UPS Family.

The Buzzer will make a continuous beep or periodic beep (about 1 per second).

The Alarm/Fault LED will either illuminate Yellow for Alarm or Red for Fault. Additional LEDs that will illuminate are Yellow Battery LED, and the Blue Inverter LED.

Error Code	Error Description	Error Type	Buzzer	LED
2	Inverter fault (bridge is shorted)	Fault	Continuous	Fault On
9	Fan fault	Fault	Continuous	Fault On
12	Initial fault	Fault	Continuous	Fault On
13	Battery Charger fault	Fault	Continuous	Fault On
15	DC Bus over voltage	Fault	Continuous	Fault On
16	DC Bus below voltage	Fault	Continuous	Fault On
17	DC bus unbalance	Fault	Continuous	Fault On
18	Soft start failed	Fault	Continuous	Fault On
19	UPS Inside Over Temperature	Fault	Periodic	Fault On
20	Heatsink Over Temperature	Fault	Periodic	Fault On
26	Battery over voltage	Alarm	Periodic	Fault Blink
27	Input voltage reversed	Alarm	Periodic	Fault Blink
28	Bypass voltage reversed	Alarm	Periodic	Fault Blink
29	Output Short-circuit	Alarm	Periodic	Fault Blink
30	Input current limit	Alarm	Periodic	Fault Blink
31	Bypass over current	Alarm	Periodic	Bypass Blink
32	Overload	Alarm	Periodic	Bypass Blink
33	No battery	Alarm	Periodic	Battery Blink
34	Battery under voltage	Alarm	Periodic	Battery Blink
35	Battery low pre-warning	Alarm	Periodic	Battery Blink
36	Overload time out	Alarm	Periodic	Fault Blink
37	DC component over limit.	Alarm	Periodic	Bypass Blink
39	Mains volt. Abnormal	Alarm	Periodic	Battery On
40	Mains freq. abnormal	Alarm	Periodic	Battery On
41	Bypass Not Available	Alarm	Periodic	Bypass Blink
42	Bypass unable to trace	Alarm	Periodic	Bypass Blink
45	EPO Activated	Alarm	Periodic	Bypass Blink



Sales, Marketing, Technical and Channel representative
of Panduit in Middle East & Africa.
info@itrident.com
www.itrident.com